USER MANUAL

SIMPRO DUMPMASTER®



Copyright © 2021 Simpro Handling Equipment Ltd.

No part of this document may be reproduced or transmitted in any form or by any means, electronic, mechanical, photocopying, recording, or otherwise, without the written permission of Simpro Handling Equipment Ltd.

For the purposes of standards compliance and international conformity, this document uses Système International (SI) units. These may be converted to Imperial units as follows:

1 kilogram (kg) = 2.2 pounds (lb)

1 metre (m) = 1000 millimetres (mm) = 39.37 inches (in) = 3.28 feet (ft) = 1.09 yards (yd)

The following stylistic conventions are used throughout this document:

 Point of interest.

 Point of warning or safety hazard.

§ Internal section reference or hyperlink

 Simpro partcode or SKU

Any errors in this document should be reported by email to info@simpro.world

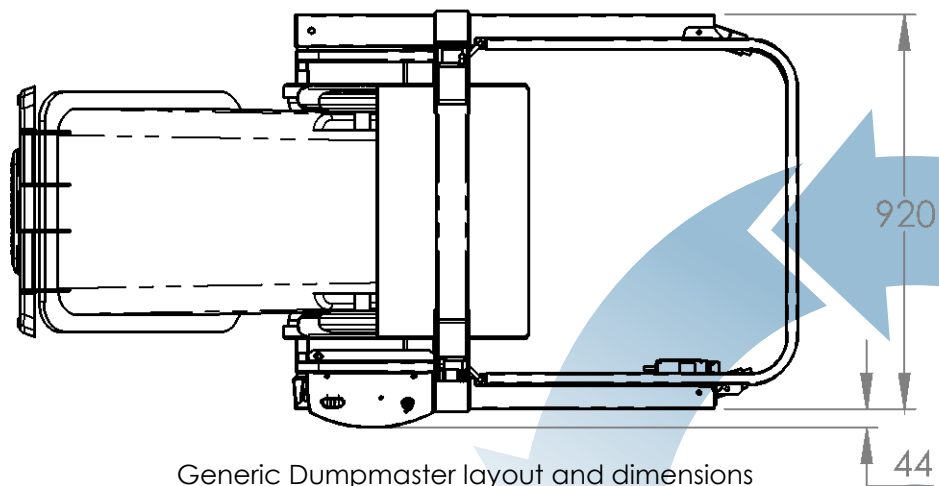
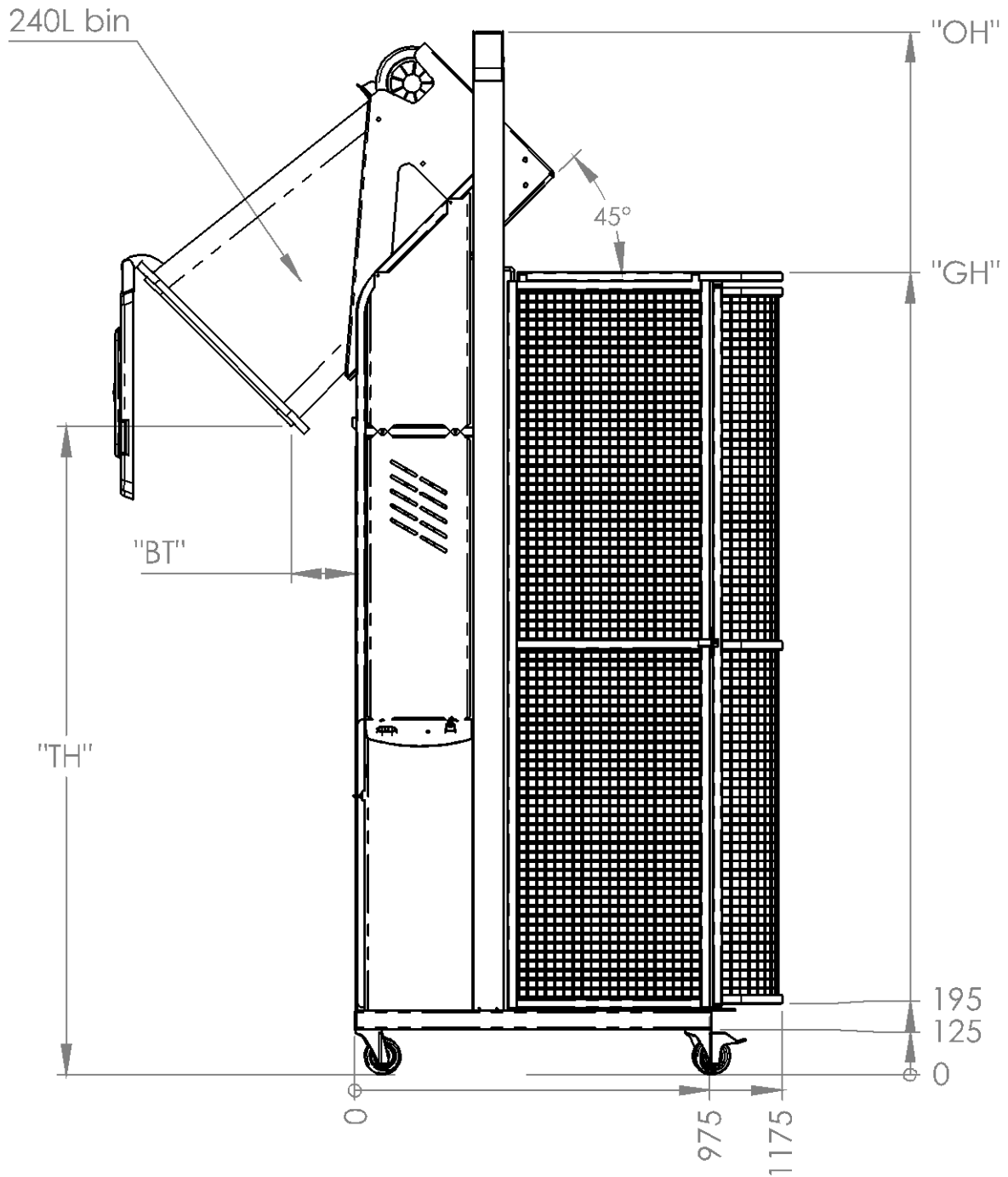

Generic Dumpmaster layout and dimensions

Contents

1. Product Overview	5
1.1 Key features.....	5
1.2 Construction	5
1.3 Mechanism	6
1.4 Safe Lifting Capacity	6
1.5 Duty cycle.....	6
1.6 Service life	7
1.7 Noise emissions.....	7
1.8 Environmental restrictions	7
1.9 Ingress protection	7
1.10 Notes	8
2. Safety Information	9
2.1 Safety features	9
2.2 Reasonably foreseeable misuse	9
2.3 OSH Compliance Specification Guide	9
2.4 Hazard and Risk Assessment Guide	11
2.5 Safety Norms.....	17
3. Operating Instructions	19
3.1 Before operation	19
3.2 Emplacing and removing bins	19
3.2.1 Cradle identification.....	19
3.2.2 Type-E Cradle (standard).....	21
3.2.3 Type-C Cradle	21
3.2.4 Type-A Cradle	21
3.2.5 Type-A Cradle with base.....	22
3.2.6 Type-D and Type-F Cradle	22
3.2.7 Type-X Cradle (custom)	22
3.3 Operation of controls	23
3.3.1 Control Panel identification	23
3.3.2 Standard Control Panel.....	24
3.3.3 Autocycle Control Panel.....	24
3.3.4 VSD Control Panel.....	25
3.3.5 Safety-Monitored Control Panel.....	25
4. Care and Maintenance.....	27
4.1 Quick Troubleshooting Guide.....	27
4.2 Cleaning	28
4.3 Cradle jams	28
4.4 Electrical System (battery)	31
4.4.1 International conformance	31

4.4.2	Voltmeter	31
4.4.3	Battery charging	31
4.4.4	Batteries	32
4.4.5	Battery charger	32
4.4.6	Appliance inlet.....	32
4.4.7	Isolator switch	32
4.4.8	Circuit breaker.....	32
4.4.9	Solar panel.....	33
4.5	Electrical System (3-phase mains)	34
4.5.1	International conformance	34
4.5.2	Appliance inlet.....	34
4.5.3	Isolator switch	34
4.5.4	Transformer	34
4.6	Electrical System (1-phase mains)	35
4.6.1	International conformance	35
4.6.2	Appliance inlet.....	35
4.6.3	Isolator switch	35
4.6.4	Transformer	35
4.6.5	Variable Speed Drive	35
4.7	Hydraulic System	37
4.7.1	Powerpack	37
4.7.2	Control valves.....	37
4.7.3	Lift ram.....	37
4.7.4	Hydraulic fluid.....	37
4.7.5	Maintenance.....	37
4.7.6	Hydraulic system schematic	38
4.8	Safety door and interlock	38
4.9	Safety-Monitoring System (CAT3/CAT4 only).....	41
5.	Assembly, Handling, Transport & Storage.....	43
6.	Preventative Maintenance Inspections.....	45
6.1	Pre-inspection checklist	45
6.2	Weekly inspection.....	45
6.3	Monthly inspection	47
6.4	Annual inspection	49
7.	Spare Parts	51
8.	Warranty.....	53
9.	EC Declaration of Conformity	55
10.	Notes	56

I. Product Overview

Congratulations on your purchase of a Simpro Dumpmaster bin-tipping machine. Dumpmaster is probably the safest and most reliable bin tipper on the market, having been in continuous production for more than thirty years.

Dumpmaster is very versatile and can be used in numerous applications, ranging from emptying rubbish bins into skips to pouring food ingredients into mixers. Regardless of the application, Dumpmaster has proven to be safe, reliable, and economical to operate, year after year.

1.1 Key features

Key features of the Dumpmaster include:

1. A unique tipping action whereby bins are lifted straight up, and then gently rolled forward around the lip of the skip or hopper being emptied into. Benefits of this design include a small 'footprint', and a wide range of tipping heights available, from 700mm to more than six metres.
2. A standard weight capacity of 250kg.
3. A very reliable, maintenance-free design.
4. A fully hot-dip galvanised frame and cradle as standard (with options for full or partial stainless steel for hygiene-critical areas).
5. A standard cradle which lifts almost all EN840 wheelie bins without clamping or retaining.
6. A modular design which can be easily modified to suit a wide range of non-standard bin sizes, shapes, and weights.



1.2 Construction

The Dumpmaster consists of a steel frame with vertical masts and stabilizing legs, bin cradle, hydraulic ram, hydraulic powerpack, powerpack cover, control panel, electronic control systems, guarding, castor wheels, and power lead or charging cable.

1.3 Mechanism

When the RAISE button is pressed, a hydraulic ram is extended, which pulls on an arrangement of chains, causing the bin cradle to travel vertically in the masts. The cradle is inverted at the appropriate height by an arrangement of arms, rollers, and a curved track.

The ram is supplied by a hydraulic power pack, which may have a 3-phase, 1-phase, battery, or compressed-air motor. Electrical, hydraulic, and / or mechanical control mechanisms allow the operator to raise or lower the bin in a controlled manner.

1.4 Safe Lifting Capacity

The Safe Lifting Capacity of the standard Dumpmaster is **250kg (550lb)**.

Some machines may be specified with different capacities. Refer to the rating plate to verify the manufacturer's rated Safe Lifting Capacity on any given machine.

 Safe Lifting Capacity is a gross figure, referring to the weight of the bin, its contents, and any other external objects which have been placed on the cradle.

 Never attempt to lift more than the factory-designated Safe Lifting Capacity.

1.5 Duty cycle

The duty cycle of the Dumpmaster depends on the type of power supply and powerpack that is fitted to the machine, as well as various environmental factors and the manner in which the machine is used. The figures given below are estimates only.

Power supply	Duty Cycle tipping at 1800mm		
	Throughput (net tipped material)	No. of bins equivalent (avg. ~100kg each)	Units
24V/20Ah Battery*	10,000kg	100 bins	Per charge
24V/20Ah Battery* on continuous charge	3000kg	30 bins	Per hour
24V/20Ah Battery* with Solar Kit	3,000kg	30 bins	Per day**
Mains, 3-Phase ~415VAC	12,000kg	120 bins	Per hour
Mains, 1-Phase ~230VAC	6,000kg	60 bins	Per hour

*2x 12V/20Ah batteries in series; default from 2015 **Subject to weather, latitude, and panel orientation; see §4.4.9

 Powerpack specifications can usually be found on the machine's rating plate.

1.6 Service life

The Dumpmaster nominal service life is as follows:

Average Gross Bin Weight	Nominal service life
< 100kg	200,000 cycles
100kg – 200kg	150,000 cycles
200kg – 250kg	100,000 cycles
250kg – 300kg	75,000 cycles
> 300kg	50,000 cycles

1.7 Noise emissions

The noise emissions of the Dumpmaster in standard operation have been assessed as not exceeding ~60 dB(A) at the operator's ear.

Operators are not required to wear hearing protection but are recommended to do so if using the machine on a constant basis.

 ISO standards for machinery safety specify that noise emissions are to be measured in A-weighted decibels (dB(A)), a unit of volume which is adjusted to reflect the sensitivity of human hearing. The measurements are taken at a point 1.6 metres above the ground at the operator's working position.

1.8 Environmental restrictions

The Dumpmaster may be used indoors or outdoors. However, the following restrictions apply:

1. Minimum floor area 2 square metres, with a clear passage to exits;
2. Height above sea level not more than 1000m;
3. Ambient temperature not higher than +40°C and not lower than -10°C;
4. At ambient temperatures above 35°C, the relative humidity should not exceed 50%; at lower temperatures, higher relative humidity is permitted;

 Never operate the machine in explosive, corrosive, acidic or alkaline environments.

1.9 Ingress protection

Item	IP Rating
Push buttons, switches, and lamps	IP66
Door interlock	IP66
Coded magnetic switch	IP66
Motor	IP54 (note additional protection provided by covers)
Overall	IP56 (optional upgrade to IP66 or IP69K)

1.10 Notes

1. This User Manual describes approved procedures for the operation, maintenance, and routine inspection of the Dumpmaster hydraulic bin-tipping machine.
2. This manual is written in English, and is to be considered the 'Original Instructions' for the purposes of EU Machinery Directive 2006/42/EC.
3. Operator(s) must read and understand this manual before using the machine.
4. If the machine is to be leased, sold or otherwise transferred, then this manual shall accompany the machine.
5. This is a generic manual. Simpro reserves the right to change the design of our products at any time without notification. In cases where the manual does not correspond with the actual product, use the manual as a reference guide only, and contact your authorized Simpro agent for assistance if required.
6. Contact your authorized Simpro agent if you encounter any problems or faults with the machine.
7. Errors in this manual should be reported by email to info@simpro.world.

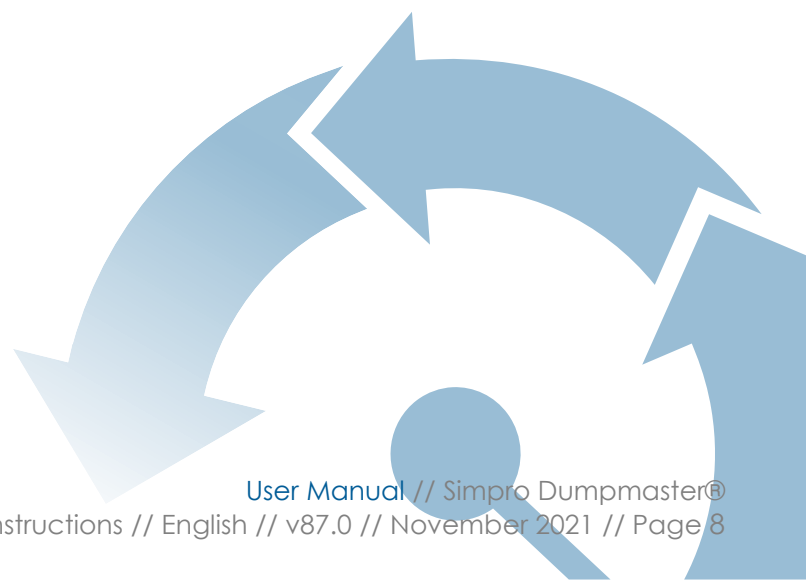

2. Safety Information

The Dumpmaster has been designed to be as safe as possible without restricting the ease-of-use and versatility of the machine.

⚠ A Hazard and Risk Assessment should be undertaken before the machine is used for the first time, as described in §2.4.

2.1 Safety features

The safety features of the standard Dumpmaster design are as follows:

1. Welded mesh and sheet-metal panels prevent personnel access to all moving parts.
2. A safety interlock system which disables the machine unless the door is shut, and electrically locks the door as soon as the cradle leaves the ground.
3. A tipping action which maintains the weight of the bin within the machine footprint.
4. A pressure-compensating lowering valve which automatically regulates the lowering speed regardless of the weight of the bin.
5. A control system which either:
 - a. stops the machine unless continuous operator input is received, or;
 - b. has a prominent EMERGENCY STOP button to disable the machine.

2.2 Reasonably foreseeable misuse

The reasonably foreseeable misuse considered in the standard Dumpmaster design is as follows:

1. Attempts to use the machine by untrained operators;
2. Attempts to empty bins that the cradle is not specifically designed to hold;
3. Attempts to bypass the door interlock or other safety systems;
4. Attempts to clear spilt material from inside the guarding without proper procedures;
5. Attempts to clean the machine without following proper procedures.

2.3 OSH Compliance Specification Guide

Companies in most jurisdictions (including Australia, NZ, UK, USA, Canada, and the EU) are required by law to provide a safe workplace for their staff, including ensuring that all new and existing machinery is safe to operate.

Although the particulars of safety legislation differ, most countries accept that machinery is 'safe to operate' if it can be demonstrated to **comply with ISO 13849-1:2015 (or a regional equivalent thereof)**.

ISO 13849-1:2015 may call for additional guarding and safety features, depending on the particular circumstances in which a machine is to be used. The purpose of this section is to assist potential Dumpmaster owners to determine whether special safety features may be required on their machine.

- ⚠ ISO 13849-1:2015 is a machinery-safety standard issued by the International Standards Organisation. It provides safety requirements and guidance on the principles for the design and integration of safety-related parts of control systems (SRP/CS), including the design of software.
- ⚠ ISO 13849-1 has been modified for local conditions and reissued under different terminology by some national standards authorities. In Australia and New Zealand, the derivative standard is called AS/NZS 4024.1:2014.
- ⚠ In the USA, ANSI standards are commonly used to demonstrate the safety of machinery, rather than ISO 13849-1. However, since the US model relies largely on 'best practise' and 'liability' to enforce workplace H&S norms, US companies who demonstrate machinery safety using ISO 13849-1 may be considered to have met or exceeded their H&S obligations.

2.3.1 The ISO 13849-1:2015 safety model

Unlike the 'system architecture' model used by earlier safety standards, ISO 13849-1:2015 uses a 'functional safety' model of machinery safety. That is, it takes account of the reliability of parts as well as other factors to create a comprehensive measure of the risk reduction achieved by a safety function – an indicator called **Performance Level (PL)**.

The standard defines five Performance Levels, ranging from **PL(a)** (lowest performance) to **PL(e)** (highest performance).

The standard also defines the Performance Level that a given safety function must achieve to reduce the risk to an acceptable level – a value called **Performance Level required (PLr)**.

2.3.1.1 Determining the Performance Level required (PLr)

As defined by the ISO 13849-1:2015 safety model, the minimum acceptable PLr for any given safety function is based on three input parameters:

1. Severity of injury expected from the associated hazard
2. Frequency and/or duration of exposure to the associated hazard
3. Possibility of manually avoiding the associated hazard

The following table may be used to determine the acceptable PLr from these parameters.

Safety Function PLr Determination Table			
Severity of injury expected from hazard	Frequency and/or duration of exposure to hazard	Possibility of manually avoiding the hazard	Minimum acceptable PLr
Slight injury (reversible)	Seldom to quite often and/or exposure time is short	Possible under specific conditions	PL(a)
		Scarcely possible	
	Frequent to continuous and/or long exposure time	Possible under specific conditions	PL(b)
		Scarcely possible	
Serious injury or death (irreversible)	Seldom to quite often and/or exposure time is short	Possible under specific conditions	PL(c)
		Scarcely possible	
	Frequent to continuous and/or long exposure time	Possible under specific conditions	PL(d)
		Scarcely possible	

To demonstrate compliance with ISO 13849-1:2015, the minimum acceptable PLr of the safety functions must be assessed **for each identified hazard in the specific conditions in which the machine is to be used.**

 The safety function PLr may be assessed as part of the regular Hazard and Risk Assessment described in §2.4. Although this assessment includes all hazards intrinsic to the Dumpmaster design, other safety functions may be necessary to address hazards specific to your intended conditions of use. These can be assessed in the blank spaces provided.

2.3.1.2 Achieving the Performance Level required (PLr)

As standard, all hazards intrinsic to the Dumpmaster design are addressed by safety functions **with a minimum performance of PL(c).**

Therefore, customised safety systems are only required in the following cases:

1. The customer's assessment identifies that hazards exist which have been addressed in the standard Dumpmaster design, but which, due to conditions specific to their intended conditions of use, require safety function performance of PL(d) or PL(e).
2. The customer's assessment identifies that hazards exist which are entirely specific to their intended conditions of use, and which have therefore not been addressed in the standard Dumpmaster design.
3. The customer is subject to corporate policies, union contracts, OSH regulations or other external factors which demand safety function performance of PL(d) or PL(e), irrespective of the ISO 13849-1:2015 safety model.

In any of these cases, information about the required safety function PLr should be provided to Simpro before placing an order. Simpro will then propose additional or updated systems to achieve the PLr in compliance with ISO 13849-1:2015. This may include any or all of the following:

- Upgrade of control system architecture to Category 3 or Category 4
- Additional guarding panels
- Remote control systems
- Training of personnel
- Signage and floor markings

2.4 Hazard and Risk Assessment Guide

Most jurisdictions require machinery owners to conduct a Hazard and Risk Assessment for their equipment, which considers all relevant factors such as the area it is used, the skill and training of operators, the proximity of other persons, frequency of use, etc.

The following section is not a complete site-specific Hazard and Risk Assessment, but an assessment of the risk factors that are intrinsic to the Dumpmaster design. Blank template spaces are provided for additional site-specific hazards.

 The procedure for carrying out a Hazard and Risk Assessment is typically defined with reference to ISO 12100:2010, issued by the International Standards Organisation. This

standard describes procedures for identifying hazards and estimating and evaluating risks during relevant phases of a machine life cycle.

 As with all powered industrial equipment, some hazards will remain despite any precautions undertaken by the manufacturer or owner of the machine. It is essential that operators are aware of these residual hazards and what they must do to prevent harm to themselves or to others, as set out in §2.4.3.

2.4.1 ISO 12100:2010 risk assessment model

In the ISO 12100:2010 risk assessment model, each identified hazard is given a Risk Factor, from which is derived a final Risk Evaluation. These parameters can be determined as follows.

2.4.1.1 Determining Risk Factor

The Risk Factor associated with any given hazard may be calculated using the following table, with the formula: **Risk Factor = LO x FE x DPH x NP:**

LO	Likelihood of Occurrence	FE	Frequency of Exposure	DPH	Degree of Possible Harm	NP	Number of Persons at risk
0.1	Impossible, or possible only in extreme circumstances	0.1	Infrequently	0.1	Scratch or bruise	1	1 – 2 persons
0.5	Highly unlikely though conceivable	0.2	Annually	0.5	Laceration, mild ill-health	2	3 – 7 persons
1	Unlikely but could occur	1	Monthly	1	Break minor bone or illness (temporary)	4	8 – 15 persons
2	Possible but unusual	1.5	Weekly	2	Break major bone or illness (permanent)	8	16 – 50 persons
5	Even chance – could happen	2.5	Daily	4	Loss of 1 limb or eye/serious illness (temporary)	12	51 or more persons
8	Probable, or not surprising	4	Hourly	8	Loss of 2 limbs or eyes/serious illness (permanent)	-	-
10	Likely, or only to be expected	5	Constantly	15	Fatality	-	-
15	Certain, or no doubt	-	-	-	-	-	-

2.4.1.2 Evaluating the Risk

Once a Risk Factor has been calculated, the risk can be evaluated using the following table:

Risk Factor:	0-1	2-5	6-10	11-50	51-100	101-500	501-1000	1001 +
Evaluation:	Negligible	Very Low	Low	Significant	High	Very high	Extreme	Unacceptable

2.4.2 Identified Hazards

The following hazards have been identified that are intrinsic to the Dumpmaster design. For each hazard a full Risk Evaluation has been completed and control measures described.

 Blank template spaces are provided at the end for machinery owners to identify, assess and control additional site-specific hazards.

Entanglement or amputation of fingers or limbs in moving parts										
Operator	LO:	0.5	FE:	4	DPH:	1	NP:	1	Risk Factor:	2
Guarding prevents access to all moving parts and trapping hazards.										
Other persons	LO:	1	FE:	4	DPH:	1	NP:	1	Risk Factor:	4
As above.										
Control measures	Operators are responsible to obey warning signs fitted to the machine and instructions, regarding keeping himself and others clear of all moving parts.									
Comments	The Dumpmaster is designed so that trapping hazards are eliminated, minimized, or isolated.									
Crushing by unauthorized rapid descent of cradle										
Operator	LO:	0.5	FE:	4	DPH:	1	NP:	1	Risk Factor:	2
The operator is protected from the cradle by the frame and guarding during operation. A door safety interlock ensures that the door can only be opened when the cradle is on the ground, and the cradle cannot be raised unless the door is closed and locked. Significant safety margins ensure that the probability of failure of any steel, hydraulic, or control parts failing is very low.										
Other persons	LO:	0.5	FE:	4	DPH:	1	NP:	1	Risk Factor:	2
As above.										
Control measures	Operators are responsible to obey warning signs fitted to the machine and instructions, regarding keeping himself and others away from the area under the cradle when raised. The machine must be regularly maintained, and all faults repaired immediately.									
Comments	A hydraulic speed-control valve limits the maximum speed of descent in normal use.									
Operator or others being hit by falling or flying debris										
Operator	LO:	1	FE:	4	DPH:	0.5	NP:	1	Risk Factor:	2
The operator is protected from the cradle by the frame and guarding during operation. There is some risk if items such as broken glass are being tipped.										
Other persons	LO:	1	FE:	4	DPH:	0.5	NP:	1	Risk Factor:	2
There is some risk to others standing close to the bin if items such as broken glass are being tipped										
Control measures	Operators are responsible to obey all instructions and warning signs regarding keeping himself and others away from the machine while in use. If tipping items such as glass, metal or liquids, glasses and gloves should be worn									
Comments										

Crushing if the machine falls over										
Operator	LO:	0.5	FE:	2.5	DPH:	1	NP:	1	Risk Factor:	1.25
	Low risk as the Dumpmaster is very stable and the bin centre of gravity remains well within the machine's footprint throughout the tipping cycle.									
Other persons	LO:	0.5	FE:	2.5	DPH:	1	NP:	1	Risk Factor:	1.25
	As above.									
Control measures	Do not operate on soft ground, or ground with slope ratio greater than 1:12. Never attempt to empty liquids from closed-top drums.									
Comments										
Electrocution or electric shock										
Operator	LO:	1	FE:	4	DPH:	15	NP:	1	Risk Factor:	60
	Some risk is always present with mains leads.									
Other persons	LO:	1	FE:	4	DPH:	15	NP:	1	Risk Factor:	60
	As above.									
Control measures	Ensure a Residual Current Device (RCD) is fitted to all power sockets. Check all leads frequently and repair or replace if damaged. All leads should be checked and tagged by a registered electrician at regular intervals.									
Comments	Mains-powered Dumpmasters are earthed and comply with AS60204.1. The charger on battery-powered Dumpmasters is double-insulated.									
Contamination from tipping toxic powder and liquid										
Operator	LO:	2	FE:	4	DPH:	1	NP:	1	Risk Factor:	8
	Great care should be taken when tipping powder or liquids. If the product could cause any harm whatsoever to the operator or to any other person, ensure all persons are well protected. An operator screen may be fitted.									
Other persons	LO:	2	FE:	4	DPH:	1	NP:	1	Risk Factor:	8
	As above.									
Control measures	The operator must wear appropriate protective equipment, and ensure that all other persons are well clear of the area. Powder should only be tipped when there is no wind, and/or a wind shield should be installed.									
Comments	Substances of a toxicity that cannot be protected against with PPE should not be emptied with a Dumpmaster. Alternative methods should be used.									
Damage to skin when used in extreme weather conditions										
Operator	LO:	2	FE:	4	DPH:	1	NP:	1	Risk Factor:	8
	If the machine is to be used in extreme cold or heat, the operator must wear gloves and other suitable Personal Protective Equipment.									
Other persons	LO:	2	FE:	4	DPH:	1	NP:	1	Risk Factor:	8
	As above.									
Control measures	Operators must wear appropriate Personal Protective Equipment (PPE) when operating machinery in extreme weather conditions.									
Comments	See §1.8 for Dumpmaster environmental restrictions.									



Site-specific hazard:									
Operator	LO:		FE:		DPH:		NP:		Risk Factor:
Other persons	LO:		FE:		DPH:		NP:		Risk Factor:
Control measures									
Comments									
Site-specific hazard:									
Operator	LO:		FE:		DPH:		NP:		Risk Factor:
Other persons	LO:		FE:		DPH:		NP:		Risk Factor:
Control measures									
Comments									
Site-specific hazard:									
Operator	LO:		FE:		DPH:		NP:		Risk Factor:
Other persons	LO:		FE:		DPH:		NP:		Risk Factor:
Control measures									
Comments									
Site-specific hazard:									
Operator	LO:		FE:		DPH:		NP:		Risk Factor:
Other persons	LO:		FE:		DPH:		NP:		Risk Factor:
Control measures									
Comments									

Site-specific hazard:										
Operator	LO:		FE:		DPH:		NP:		Risk Factor:	
Other persons	LO:		FE:		DPH:		NP:		Risk Factor:	
Control measures										
Comments										
Site-specific hazard:										
Operator	LO:		FE:		DPH:		NP:		Risk Factor:	
Other persons	LO:		FE:		DPH:		NP:		Risk Factor:	
Control measures										
Comments										

2.4.3 Residual Hazards

As with all industrial lifting equipment, certain 'residual hazards' may be present despite any guarding or safety measures implemented by the manufacturer.

The machinery owner has a legal responsibility to identify such residual hazards, and to take **all reasonable precautions** to eliminate, isolate, or minimize them. This may include any or all of the following:

- Monitoring and enforcing the training of operators.
- Design and implementation of Standard Operating Procedures.
- Using disciplinary measures to enforce the Standard Operating Procedures.
- Posting signage, floor marking, or other warnings as appropriate.
- Taking steps to develop a culture of safety-awareness and open communication within the workplace.

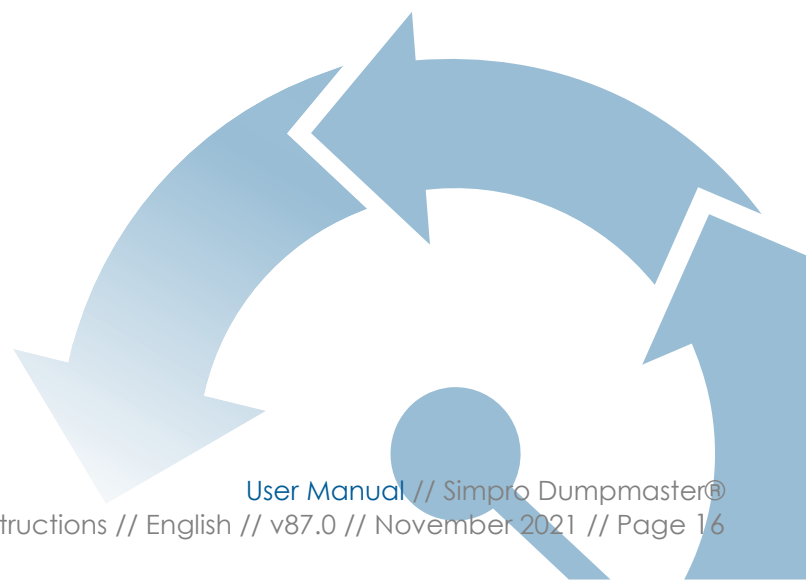

2.5 Safety Norms

The following safety norms must be observed for the safe use of a Dumpmaster bin lifter.

Only trained and authorised personnel may use the machine.

Operators must read and obey all instructions displayed on the machine.

Never operate the machine on soft ground, or ground with a slope ratio greater than 1:12.

Never operate machine on the edge of a raised dock or platform, unless designed for that application.

Never operate the machine with any covers or guards removed.

Never attempt to empty the contents of closed-top drums, unless the machine is securely bolted down.

All persons other than the operator must keep at least two metres clear while the machine is in use.

Always keep hands and feet well clear of the bin and cradle when operating.

Never place limbs, feet or foreign objects under the side guards or safety door.

Never attempt to empty over-filled bins, or bins weighing more than 250kg.

Before connecting machine to mains supply, ensure voltage and frequency correspond with that listed on the rating plate.

Do not use an extension lead longer than 15 metres to connect the machine to mains power.

Do not operate if power lead, insulation or power plugs are damaged.

Do not connect a damp power plug or socket.

Ensure the power supply socket is fitted with a residual current device.

Ensure there is complete continuity between the machine and an effective earthing system which complies with local and national regulations. The manufacturer cannot be held liable for the consequences of an inadequate earthing system.

3. Operating Instructions

3.1 Before operation

Before operating a Dumpmaster, check the following points to ensure that the machine is stable and safe to use:

1. The machine is on firm ground with a slope ratio of less than 1:12.
2. All covers and safety guards are in place.
3. The wheel brakes are applied, and/or the feet are wound down onto the ground.
4. All personnel other than the operator are well clear of the machine.
5. The cradle is fully lowered.
6. The key is inserted and turned to the ON position.
7. The battery indicator (if fitted) shows an acceptable level of charge.

3.2 Emplacing and removing bins

⚠ All personnel using the machine must know how to correctly emplace and remove bins from the machine. Bins that are not correctly emplaced may come loose and damage the machine while being lifted, or fall out when inverted.

The bin cradle is designed to allow bins to be emplaced and removed easily, while also holding them securely throughout the lifting and tipping cycle. A range of different cradles may be installed, depending on the types of bin that the machine needs to empty. Use the following table to identify the correct instructions for your machine.

3.2.1 Cradle identification

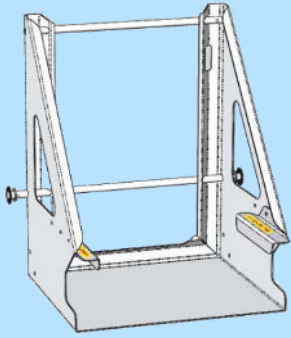
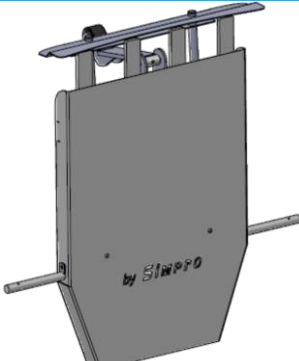
Cradle Type	Primary Usage	Bin Compatibility	Cradle Image	Refer
Type-E (EN840 base-lift cradle)	Standard waste and recycling applications in EU, UK, AU, NZ, Asia, Africa, and parts of South America	EN840 mobile garbage bins (wheelie bins)		§3.2.2
Type-C (EN840 comb-lift cradle)	Specialised waste and recycling applications (primarily with 360-litre bins) in EU, UK, AU, NZ, Asia, Africa, and parts of South America		- 60L - 80L - 120L - 140L - 240L - 360L	

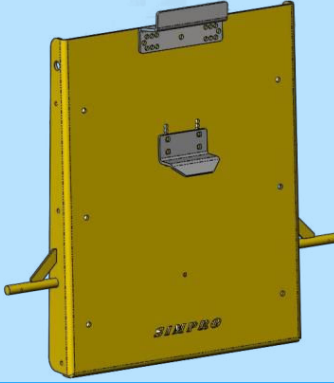
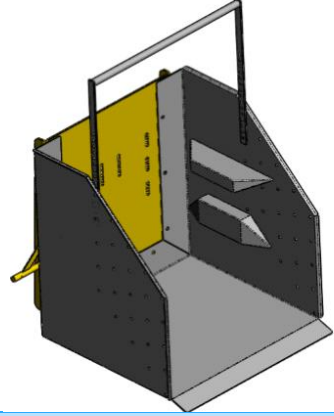
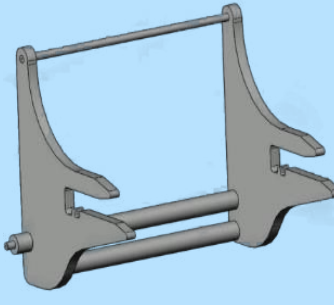
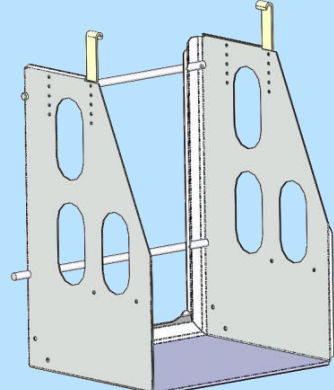
Cradle Type	Primary Usage	Bin Compatibility		Cradle Image	Refer
Type-A (ANSI bar-lift cradle)	Standard waste and recycling applications in USA, Canada, and parts of South America	ANSI Z245.60 (Type-B) Trash Carts	- 32 gal - 48 gal - 64 gal - 96 gal		§3.2.4
Type-A with base (ANSI bar-lift cradle with base)	Specialised waste and recycling applications in USA, Canada, and parts of South America	BRUTE® Bins 205L Drums Plastic Tubs Customs Bins	- 10 gal - 20 gal - 28 gal - 32 gal - 40 gal - 44 gal - 55 gal		§3.2.5
Type-D (DIN9797)	Food processing applications	DIN9797 Eurobins	- 120L - 200L - 300L		§3.2.6
Type-F (Foodcap)		Foodcap® Capsules	- 180L		
Type-X	Custom applications	BRUTE® Bins 205L Drums Plastic Tubs Customs Bins			§3.2.7

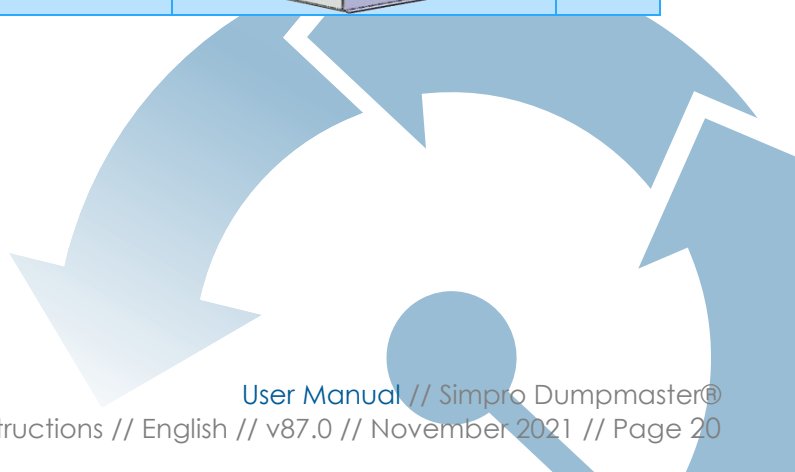

3.2.2 Type-E Cradle (standard)

3.2.2.1 Emplacing bins

Open the door and place the wheelie bin onto the cradle. For full-size 240L bins, both wheels should be positioned into a catch (on either side of the cradle). For smaller bins such as 60L, 80L, 120L and 140L, only the left-hand wheel needs be positioned into a catch. Once the bin is correctly emplaced, close the door.

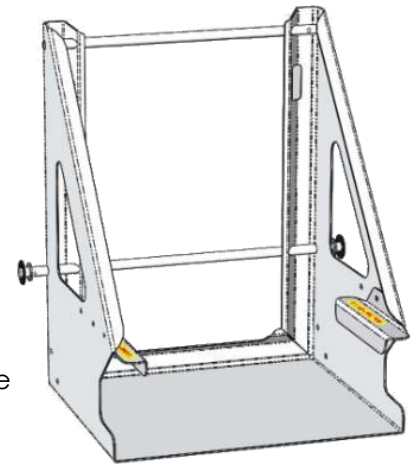

- ⚠ The wheel catches are designed to work with standard EN840 wheelie bins from leading brands such as Europlast, Sulo, ESE, Weber, Craemer, OnePlastics and Trident.
- ⚠ Some smaller bin manufacturers use axles of different lengths. If the distance between the wheels is slightly too large or small, the wheels may jam against the catches, preventing a secure emplacement. Should this occur, simply unbolt and remove the right-hand wheel catch. All bins can be securely retained using the left-hand catch only.
- ⚠ Some smaller bin manufacturers use tyres which are too wide to fit inside the wheel catches. Should this issue occur, simply insert additional packers (flat washers) onto the wheel catch mounting bolts, to increase the spacing as needed.

3.2.2.2 Removing bins

Open the door and, using the grab-handles provided, gently remove the wheelie bin from the cradle.

3.2.3 Type-C Cradle

3.2.3.1 Emplacing bins

Open the door and place the wheelie bin into the machine, positioned centrally against the cradle backplate. Take care that the lifting teeth are properly hooked into the bin combing; smaller bins such as 60L and 80L may need to be tilted or lifted slightly to ensure a proper 'catch'. Once the bin is correctly emplaced, close the door.

3.2.3.2 Removing bins

Open the door and, using the grab-handles provided, gently remove the wheelie bin from the cradle. Some smaller bins may need to be tilted or lifted slightly to detach them from the lifting teeth.

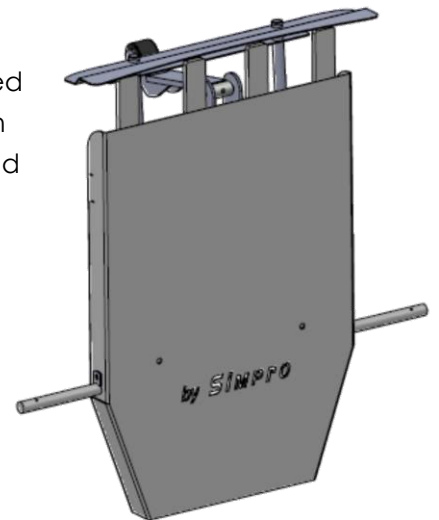

3.2.4 Type-A Cradle

3.2.4.1 Emplacing bins

Open the door and place the trash cart into the machine, positioned centrally against the cradle backplate. Take care that the lifting catches are properly hooked into the front of the cart; some carts may need to be tilted or shaken slightly to ensure a proper 'catch'. Once the cart is correctly emplaced, close the door.

3.2.4.2 Removing bins

Open the door and, using the grab-handles provided, gently remove the trash cart from the cradle. Some carts may need to be tilted or shaken slightly to detach them from the lifting catches.

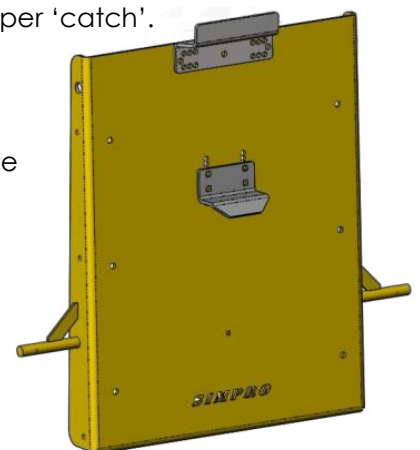

3.2.5 Type-A Cradle with base

3.2.5.1 Emplacing bins

Open the door and place the bin, drum, or container onto the cradle, positioned centrally against the backplate. Once the bin is correctly emplaced, close the door.

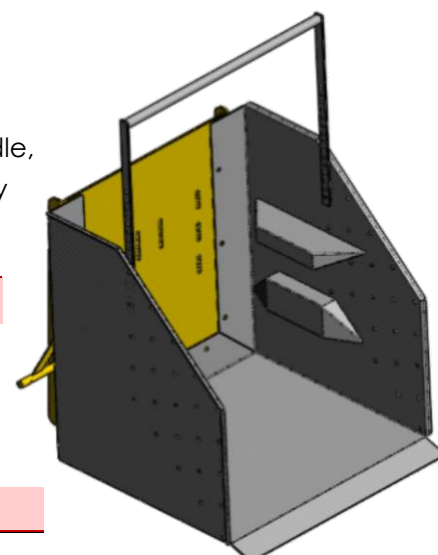

- ⚠ When moving heavy non-wheeled containers, it is recommended to use a dolly, hand truck or forklift attachment.
- ⚠ The catch arm(s) should be positioned to hold the top edges of the bin, with a maximum free travel of 25mm (1 inch). The arm(s) can be unbolted and repositioned to allow emptying bins of many different sizes.

3.2.5.2 Removing bins

Open the door and, holding the upper lip of the bin, drum, or container, gently remove it from the cradle.

3.2.6 Type-D and Type-F Cradle

3.2.6.1 Emplacing bins

Open the door and wheel the bin into the cradle, positioned centrally, until it is firmly against the stop-buffers. Take care that both trunnions are properly seated in the lifting arms; some bins may need to be tilted or shaken slightly to ensure a proper 'catch'. Once the bin is correctly emplaced, close the door.

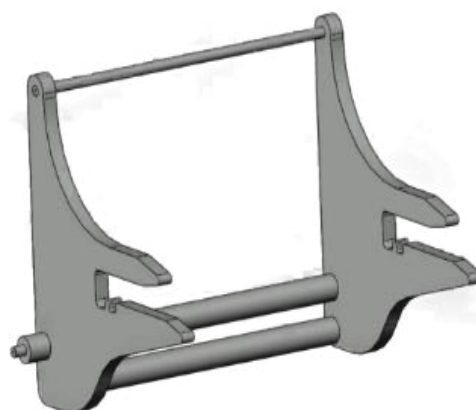

3.2.6.2 Removing bins

Open the door, and holding the grab-handle on the Eurobin (or the upper lip of the Foodcap® capsule), gently remove it from the cradle.

3.2.7 Type-X Cradle (custom)

3.2.7.1 Emplacing bins

Open the door and place the bin, drum, or container onto the cradle, positioned centrally against the backplate. Once the bin is correctly emplaced, close the door.

- ⚠ When moving heavy non-wheeled containers, it is recommended to use a dolly, hand truck or forklift attachment.
- ⚠ The catch arm(s) should be positioned to hold the top edges of the bin, with a maximum free travel of 25mm (1 inch). The arm(s) can be unbolted and repositioned to allow emptying bins of many different sizes.

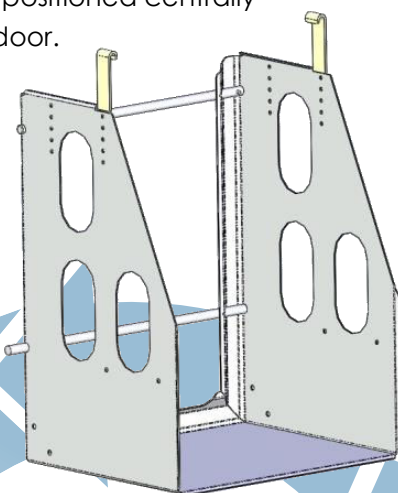

3.2.7.2 Removing bins

Open the door, and holding the upper lip of the bin, drum, or container, gently remove it from the cradle.





3.3 Operation of controls

The controls are designed to allow safe, intuitive operation of the Dumpmaster. All operators must understand how to use the controls correctly. Improper operation of the controls may cause a safety hazard or damage the machine.

A number of different control panels may be installed, depending on the particular operational and safety requirements of the Dumpmaster. Use the following table to identify the correct operating instructions for your machine.

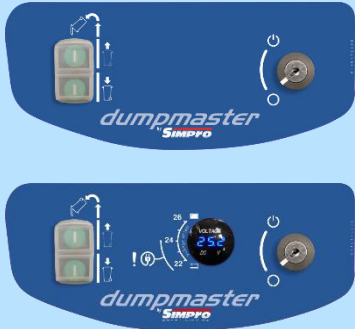
3.3.1 Control Panel identification

The control panel of the machine is normally atop the powerpack cover, but on some models, it is mounted on a separate enclosure.

Control Panel	Primary Usage	Controls	Image	Refer
Standard	Standard machines	<ul style="list-style-type: none"> - RAISE/LOWER - KEY SWITCH - VOLTMETER (battery machines only) 		§3.3.2
Autocycle	Machines with an autocycle controller	<ul style="list-style-type: none"> - RAISE/LOWER - EMERGENCY STOP - CONTROL MODE (AUTO/MANUAL) 		§3.3.3
VSD	Machines with a Variable Speed Drive controller	<ul style="list-style-type: none"> - JOYSTICK FOR RAISE/LOWER - KEY SWITCH 		§3.3.4
Safety-Monitored	Machines with safety-monitoring systems to comply with 13849-1:2015 and AS/NZS4024 up to CAT3/CAT4	<ul style="list-style-type: none"> - RAISE/LOWER - EMERGENCY STOP - CONTROL MODE (AUTO/MANUAL) - SAFETY RESET - Panel describing the architecture of the safety-monitoring systems (CAT3/CAT4) 		§3.3.5

3.3.2 Standard Control Panel

How to operate the controls of a standard machine, with no autocycle or PLC controller.

1. Before operation, check that the machine is stable and safe to use as per §3.1.
2. Open the door and place the full bin onto the cradle, taking care that it is properly positioned as per §3.2, then shut the door.
3. **Press and hold the RAISE button** until the bin reaches the inverted position, then release. Wait for the contents of the bin to empty.
4. **Press and hold the LOWER button** until the cradle rests on the ground.
5. Open the door and remove the empty bin as per §3.2.
6. Repeat from step 1) as required.



Release the RAISE or LOWER button to stop the cradle at any time.

3.3.3 Autocycle Control Panel

How to operate the controls of a machine with an autocycle function, allowing bins to be emptied without continuous operator input.

Dumpmaster models that are fitted with an autocycle control system may be used in either 'Manual' or 'Automatic' mode, selected using a switch on the control panel.

The operating procedure for each mode is as follows:

3.3.3.1 Automatic mode

1. Before operation, check that the machine is stable and safe to use as per §3.1.
2. Open the door and place the full bin onto the cradle, taking care that it is properly positioned as per §3.2, then shut the door.
3. Turn the mode-selector switch to AUTO.
4. **Press the RAISE button once.** The cradle will automatically lift, hold the bin inverted for a short time, and return to ground level.
5. Open the door and remove the empty bin as per §3.2.
6. Repeat from step 1) as required.



Press the EMERGENCY STOP button to stop the cradle at any time.

3.3.3.2 Manual mode

1. Before operation, check that the machine is stable and safe to use as per §3.1.
2. Open the door and place the full bin onto the cradle, taking care that it is properly positioned as per §3.2, then shut the door.
3. Turn the mode-selector switch to MANUAL.
4. **Press and hold the RAISE button** until the bin reaches the inverted position, then release. Wait for the contents of the bin to empty.
5. **Press and hold the LOWER button** until the cradle returns to the ground.
6. Open the door and remove the empty bin as per §3.2.

7. Repeat from step 1) as required.

⚠ Release the RAISE or LOWER button, or press the EMERGENCY STOP button to stop the cradle at any time.

3.3.4 VSD Control Panel

⚠ How to operate the controls of a VSD machine, with a joystick to allow progressive control of the cradle lifting speed.



1. Before operation, check that the machine is stable and safe to use as per §3.1.
2. Open the door and place the full bin onto the cradle, taking care that it is properly positioned as per §3.2, then shut the door.
3. **Push the JOYSTICK FULLY FORWARD** to begin lifting the bin.
4. When the bin reaches the top of the mast and starts to invert, **gently move the JOYSTICK SLIGHTLY BACK** so that the material is poured from the bin in a controlled manner, as desired. Wait for the contents of the bin to empty.
5. **Pull the JOYSTICK FULLY BACK** until the cradle rests on the ground.
6. Open the door and remove the empty bin as per §3.2.
7. Repeat from step 1) as required.

⚠ Release the JOYSTICK to stop the cradle at any time.

3.3.5 Safety-Monitored Control Panel

⚠ How to operate a machine with an electronic PLC control unit and a CAT3 or CAT4 safety monitoring system.



Dumpmaster models that are fitted with a safety-monitored control system may be used in either 'Manual' or 'Automatic' mode, selected using a switch on the control panel.

The operating procedure for each mode is as follows:

3.3.5.1 Automatic mode

1. Before operation, check that the machine is stable and safe to use as per §3.1.
2. Open the door. If the door is locked, press the LOWER button to unlock it.
3. Place the full bin onto the cradle, taking care that it is properly positioned as per §3.2, then shut the door.
4. Turn the mode-selector switch to AUTO.
5. Press and hold the blue SAFE MODE RESET button for two seconds.
 - a. The safety system will now conduct an auto-diagnostic check. If no faults are detected, the blue light will go out and the system will enter READY MODE.
 - b. If a fault is detected, the blue light will not go out and the system will remain in SAFE MODE. The fault must be found and corrected before the machine can be used – see §4.9.

6. **Press the RAISE button once.** The cradle will automatically lift, hold the bin inverted for a short time, then return to ground level.
7. Open the door and remove the empty bin as per §3.2.
8. Repeat from step 1) as required.

 Once the cradle has lowered, the door is automatically unlocked for about 15 seconds. If the door re-locks, press the LOWER button to unlock it at any time.

 Press the EMERGENCY STOP button to stop the cradle at any time.

3.3.5.2 Manual mode

1. Before operation, check that the machine is stable and safe to use as per §3.1.
2. Open the door. If the door is locked, press the LOWER button to unlock it.
3. Place the full bin onto the cradle, taking care that it is properly positioned as per §3.2, then shut the door.
4. Turn the mode-selector switch to MANUAL.
5. Press and hold the blue SAFE MODE RESET button for two seconds.
 - a. The safety system will now conduct an auto-diagnostic check. If no faults are detected, the blue light will go out and the system will enter READY MODE.
 - b. If a fault is detected, the blue light will not go out and the system will remain in SAFE MODE. The fault must be found and corrected before the machine can be used – see §4.9.
6. **Press and hold the RAISE button** until the bin reaches the inverted position, then release. Wait for the contents of the bin to empty.
7. **Press and hold the LOWER button** until the cradle rests on the ground.
8. Open the door and remove the empty bin as per §3.2.
9. Repeat from step 1) as required.



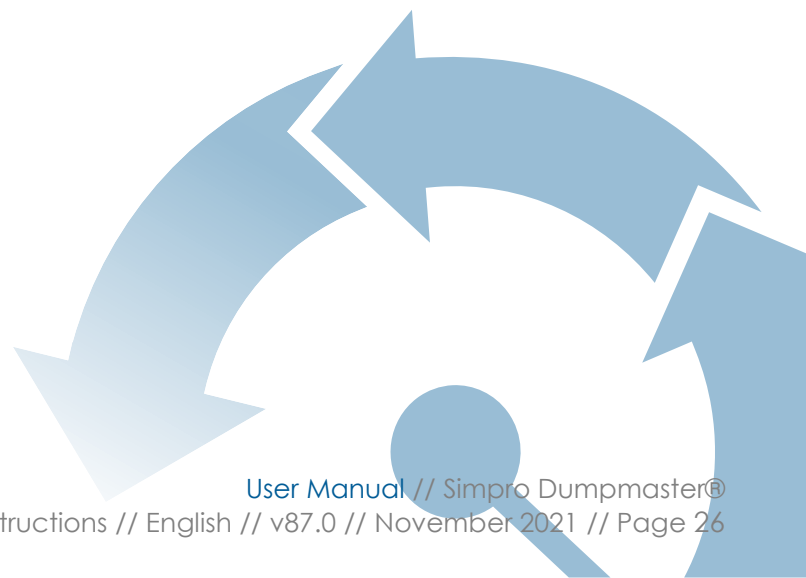

 Once the cradle has lowered, the door is automatically unlocked for about 15 seconds. If the door re-locks, press the LOWER button to unlock it at any time.

 Release the RAISE or LOWER button, or press the EMERGENCY STOP button to stop the cradle at any time.















4. Care and Maintenance

The Dumpmaster is designed to give many years of service with minimal maintenance. In the event a fault or malfunction does occur, refer to the Quick Troubleshooting Guide in §4.1 before contacting your Simpro agent for support.

-  Contact your agent if repair or service work is required.
-  All repair and service work must be carried out by qualified personnel.
-  Replacement parts must be supplied by Simpro or an authorized Simpro agent, and must be of the same design and specification as the original parts.
-  A detailed Service Manual giving specific testing and repair instructions is available on request from Simpro.

4.1 Quick Troubleshooting Guide



Refer to the Quick Troubleshooting Guide below before contacting your agent for service.

Problem	Possible Causes	Remedy	See also
The machine will not lift bins, and the motor does not run	Flat Battery	The battery needs to be charged if voltmeter reads less than 24 volts.	§4.4.3  Battery 0250050004
	Triggered circuit breaker (60A fuse on older models)	Wait 1-2 minutes for circuit breaker to auto-reset (or replace fuse). Avoid operating machine with flat battery.	§4.4.8  Breaker 0790050374  Fuse 0790050101
	Faulty up/down switch or wiring	Check and rectify – replace if necessary.	 Up/Down Switch 0790050454
	Faulty motor solenoid (battery) or contactor (3ph)	Solenoid or contactor should 'click' when the UP button is pressed – if not it may need to be replaced.	 Solenoid 0880050015  3-Phase Contactor 0250050069
	Interlock switch on door not working	Contact your agent for parts and wiring diagrams.	§4.8.3  Interlock 0790050408
The machine will not lift bins, although the motor runs	Bin too heavy	Remove material to reduce weight.	§4.3.1.1
	Pressure-relief valve set too low	Contact your agent for instructions on adjusting the pressure setting.	§4.7.2.2
	3-phase motor running in reverse	Swap phase wires in the power plug.	§4.5.2
Cradle will not come down from the fully raised position	Cradle sticking in masts	Spray inside of masts at top of slots. Smear grease on top of the curved tipping tracks. Lubricate roller arm at top of cradle.	§4.3.2
	Lift ram jamming	Contact your agent for support.	§4.3.2  Ram 0330090003
	Faulty up/down switch, wiring, or lowering valve coil	Lowering valve should 'click' when the DOWN button is pressed – if not, check the up/down switch, wiring and lowering valve coil.	§4.3.2  Up/Down Switch 0790050454  Lowering Valve Coil 0250090067
Cradle jamming part-way down	Follower roller not turning freely	Lubricate roller – replace if necessary	§4.3.2  Roller 0090120000  Bush 0140120000
	Roller arm twisted or cradle sitting out of level	Check and straighten – replace if necessary	§4.3.2  Roller Arm 0640200005

4.2 Cleaning



The machine should be cleaned with a low-pressure water jet, a microfiber cloth and a mild cleaning solution. Cleaning should only be carried out with the cradle lowered.

 Do not clean the machine with a high-pressure water jet, such as a waterblaster.

 For IP ratings of the machine and various subcomponents see § 1.9.
 If it is necessary to clean underneath the cradle, the control system can be modified to allow this while maintaining operator safety – contact your Simpro agent for support.

4.3 Cradle jams

Occasionally the bin cradle may become jammed at some point in the tipping cycle. This is usually a minor issue which may be easily rectified.

 The cradle is not powered down – it is lowered by gravity alone.
 See § 4.7 for details and schematics of the hydraulic system.

4.3.1 Cradle jams while raising

If the cradle jams while raising the cause may be either an overweight bin, or a mechanical fault, such as a bent tipping guide or misaligned roller.

4.3.1.1 Overweight bin

1. Lower the cradle to ground level, open the door and remove the bin.
2. Remove some material from the bin, then try again.

 If the pressure-relief valve is adjusted incorrectly, the cradle may stall even when lifting bins that are within the rated capacity of the machine. Adjustment of the pressure setting should only be carried out by a qualified technician with authorisation from Simpro.

4.3.1.2 Mechanical fault

1. If possible, lower the cradle to ground level, open the door and remove the bin.
2. Attempt to visually identify the cause of the jamming. The most likely causes are:
 - a. The lifting chain may have derailed from the chain guide at the top of the mast (on the opposite side to the lift ram).
 - b. The mast may have been bent or damaged, jamming one of the mast rollers.
 - c. On machines with a single 'tipping track' in the middle, the top part of the track may have been bent, interfering with the correct geometry of the follower roller.
 - d. Lack of lubrication on the follower roller or the main cradle axle.
 - e. The cradle may be out of level, due to poor adjustment of the lifting chains or to a breakage.
 - f. The roller arm(s) may be pressing against the 'tipping track' due to the cradle sitting out of level, or not being properly centred between the masts.
3. With the cradle lowered, rectify the problem by lubricating, straightening and/or realigning the mechanical components as required. If the mast is bent, you may need to contact your agent for support.

4. Close the door and run the machine through several full cycles to ensure the problem has been resolved.

4.3.2 Cradle jams while lowering



If the cradle jams on the way down, or has jammed on the way up but will not come down, it may be due to a hydraulic, electrical, or mechanical fault.

4.3.2.1 Hydraulic or electrical fault

When the LOWER button is pressed, the lowering valve should emit a 'click' sound as it opens. If it does not, the problem may be either a hydraulic or electrical fault.

1. Manually disable the safety door interlock as per §4.8.3.1, and open the door.
2. Attach lifting slings to a forklift or hoist, and carefully take the weight of the cradle.

⚠ Never place any part of your body underneath the cradle unless it is securely supported.

3. Remove the powerpack cover.
4. Unscrew the fitting attaching the steel hydraulic pipe to the powerpack, and hold the end of the pipe over a container with a capacity of at least 2 litres.
5. Lower the cradle slowly with the forklift, collecting the oil in the container.
6. Once the cradle is fully lowered, remove the bin.
7. Reconnect the hydraulic pipe and fitting, and refill the oil tank.
8. Check that the lowering valve coil  0250090067 is receiving an electrical signal. An LED lamp should glow on the coil plug when the LOWER button is pressed. If it does not, check the up/down switch and wiring.
9. If the coil is receiving an electrical signal but not opening, it may need to be cleaned:
 - a. Remove the coil from the valve stem.
 - b. Unscrew the lowering valve cartridge.  0250090055
 - c. Clean the cartridge with compressed air.
 - d. Replace the lowering valve components by reversing this procedure.
10. Replace the lowering valve, and test to see if the cradle lowers correctly.
11. Re-enable the safety door interlock as per §4.8.3.1, and run the machine through several complete lift/lower cycles with no bin in the cradle, to check that the problem has been properly resolved. If the lowering valve is still not operating correctly, it may need to be replaced – contact your agent.

4.3.2.2 Mechanical fault

If the lowering valve is operating correctly (emits a 'click' sound when the LOWER button is pressed), the problem may be a mechanical fault.

1. Manually release the safety door interlock as per §4.8.3.1, and open the door.
2. Provide support for the cradle, either with a structure underneath or with a sling holding it to the top of the main frame. Allow for it to fall no more than 50mm.

⚠ Never place any part of your body underneath the cradle unless it is securely supported.

3. Attempt to visually identify the cause of the jamming. The most likely causes are:
 - a. The lifting chain may have derailed from the plastic guide at the top of the mast (on the opposite side to the lift ram).

- b. A mast may have been bent or damaged, jamming one of the mast rollers
 - c. On machines with a single 'tipping track' in the middle, the top part of the track may have been bent, interfering with the correct geometry of the follower roller.
 - d. Lack of lubrication on the follower roller, or the main cradle axle
 - e. The cradle may be sitting out of level, due to poor adjustment of the lifting chains or to a breakage.
 - f. The roller arm(s) may be pressing against the 'tipping track' due to the cradle sitting out of level, or not being properly centred between the masts.
4. Rectify the problem by lubricating, straightening and/or realigning the mechanical components as required. If the mast is bent, you may need to contact your agent for support.
 5. Close the door and test to see if the cradle lowers correctly.
 6. Re-enable the safety door interlock as per [§4.8.3.1](#), close the door and run the machine through several full cycles to ensure the problem has been resolved.

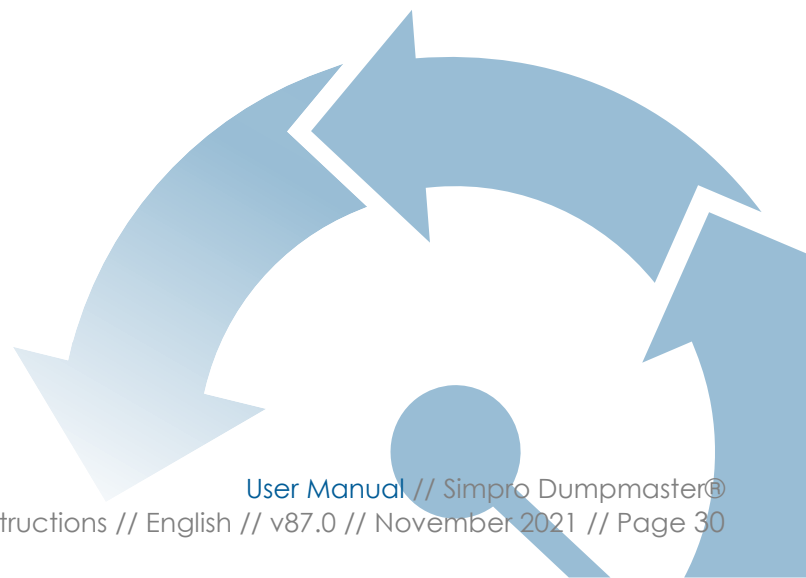

4.4 Electrical System (battery)

⚠️ If you do not operate a battery-powered machine, please disregard this section.

Battery-powered Dumpmasters are fitted with two 12V/20Ah VRLA deep-cycle gel batteries connected in series, a digital smart charger, and a series-wound 800W/24VDC motor. The control voltage is 24VDC.

The motor only runs when the RAISE button is pressed; the cradle is lowered by gravity alone. As a rule, a full charge is sufficient to empty 10 tonnes of material, but this is dependent on the tipping height and the condition of the batteries.

4.4.1 International conformance

The Dumpmaster is fitted with a digital smart charger which accepts 1-phase mains power at voltages of 85-264VAC and frequencies of 50/60Hz, with a maximum current draw of 3 Amps. This means the machine can be charged using a standard household power outlet in almost any country around the world.

4.4.2 Voltmeter 0790050067

The Dumpmaster is fitted with a voltmeter on the control panel, which is used to indicate the level of charge in the batteries. **When the voltmeter reads less than 24 volts the batteries are discharged.** The machine should not be used, and should be recharged as soon as possible.

⚠️ The voltage will fluctuate when the motor is running, so the battery state should only be checked when the machine is at rest.

⚠️ Operating a machine with a flat battery may trigger the circuit breaker (see §4.4.8). If this is bypassed, the wiring, battery and motor may be damaged by excessive current draw.

4.4.3 Battery charging

To recharge the batteries, plug one end of a 1-phase extension lead into the appliance socket on the machine, and the other end into a 1-phase mains power outlet.

A full charge usually takes about 5 hours. The machine can be used while on charge.

⚠️ The battery charger automatically adapts to different input currents, manages the charging cycle to maximise battery life, and prevents overcharging.

⚠️ The charger delivers enough power to empty a 100kg bin in about 3 minutes, which means that a battery machine can be plugged in and operated as a mains-powered machine (see §1.5).



4.4.4 Batteries 0250050004

The Dumpmaster is fitted with two 12V/20Ah VRLA deep-cycle gel batteries connected in series to deliver 24VDC (nominal) to the motor and control circuits.

The batteries are sealed and maintenance-free, with a lifespan of up to five years. However, battery life is dependent on several factors, including the number of charge cycles, the average discharge depth, and environmental conditions.

4.4.4.1 Maximising battery life

To maximize the life of the batteries, observe the following rules:

- Place the batteries on charge every night (or permanently).
- Do not allow the machine to sit with flat batteries for more than 24 hours.
- Do not operate the machine when the batteries are flat (reading less than 24V).

 The batteries are supplied with a 12-month manufacturer's warranty, separate from the warranty on the rest of the machine.

4.4.5 Battery charger 0390050006

The Dumpmaster is fitted with a digital smart charger which accepts 1-phase mains power at voltages of 85-264VAC and frequencies of 50/60Hz, with a maximum current draw of 3 Amps.

The charger outputs up to 6 Amps of continuous direct current at 27.2 Volts, for a maximum power output of 160 Watts.

 The charger is in an enclosed plastic case and is protected against short-circuit, current overload, over-voltage and over-temperature.

4.4.6 Appliance inlet NZ/AU 0790050272

The Dumpmaster is fitted with an IP66-rated appliance socket on the right-hand side of the machine (opposite the control panel). This allows the machine to be charged using a regular 1-phase extension lead.

4.4.7 Isolator switch 0210050002



The Dumpmaster is fitted with a isolator switch on the forward side of the powerpack cover. This switch isolates the batteries from the electrical systems, and should be turned OFF if the machine is to be placed in storage, or if the powerpack cover needs to be removed.

 On some older machines, the batteries will not charge if the isolator switch is turned OFF.

4.4.8 Circuit breaker 0790050374

The Dumpmaster is fitted with an auto-resetting 75A circuit breaker on the battery cable, to protect the electrical systems from excessive current draw. Once triggered, the circuit breaker will automatically reset after a period of 1-2 minutes.

 Because the current draw of the motor increases as the battery voltage decreases, operating the machine with a flat battery may trigger the circuit breaker.

 Prior to 2020 the Dumpmaster was fitted with a 60A Maxi blade-fuse instead of a circuit breaker. Replacement fuses are available from Simpro  0790050101 or any auto-parts store.

4.4.9 Solar panel 0090040077

 If you do not operate a machine with a solar panel, please disregard this section.

Battery machines may be fitted with a solar panel kit to allow operation in locations without mains power. The 80W monocrystalline solar panel (dimensions 930x673x35mm) is mounted on an adjustable steel bracket at the top of the mast, and delivers power to the battery via a 12V/24V digital regulator.

As per § 1.5, in ideal conditions the solar panel provides enough power to dump about 3,000kg of material each day, which is equivalent to about 30 full 240-litre wheelie bins. There are many factors affecting this figure, including the season, the amount of sunlight available, cloud cover, panel alignment and cleanliness, and the condition of the batteries.

 To deliver maximum power the solar panel must be correctly aligned, clean, and exposed to direct sunlight throughout the day.

4.4.9.1 Solar panel alignment

The solar panel is mounted on an adjustable steel bracket with one axis of movement. To deliver maximum power, the panel should be aligned to cast the largest-possible shadow when the sun is at its highest point in the sky. However, because the bracket has only one axis of movement, the orientation of the machine itself affects the optimum panel alignment.

Use the following guidelines to align the solar panel:

1. Ideally, orient the machine so that adjustment arc of the panel mounting bracket runs from North to South.
2. If the adjustment arc cannot be oriented North-South, the panel should be angled at 0° degrees (vertical). While this is suitable close to the equator, it will progressively reduce the power output at latitudes beyond $\pm 20^\circ$ degrees.
3. With the machine in its long-term location, **tilt the panel towards the equator** by the same number of degrees as the machine's geographic latitude.
4. If required, a further 5-10% increase in output can be achieved by tuning the panel alignment for the Summer and Winter months:
 - a. At the beginning of Spring, reduce the angle of the panel so it is equal to the machine's geographic latitude **less 15° degrees**.
 - b. At the beginning of Autumn (Fall), increase the angle of the panel so it is equal to the machine's geographic latitude **plus 15° degrees**.

 The panel angles referred to above are measured in degrees of arc from vertical.



 Without correct adjustment the solar panel may deliver as little as 20% of the theoretical maximum output. Correctly adjusting the panel when the machine is installed can increase this figure to ~70%, and adjustment twice a year can increase output to ~75% of the theoretical maximum.

4.4.9.2 Solar panel cleaning

The solar panel should be cleaned every six months, using a microfiber cloth or damp rag.

 Use appropriate height-safety equipment when servicing or cleaning the solar panel.

4.5 Electrical System (3-phase mains)

-  If you do not operate a 3-phase mains machine, please disregard this section.
-  The 3-phase mains specification is recommended for high-intensity applications.

Machines powered by 3-phase mains electricity are generally the same as other models, but use a 3-phase 2-pole electric motor to drive the hydraulic pump. The control voltage is 24VDC. In some countries an electronic VSD is also fitted in order to provide suitable current to the motor.

The motor only runs when the RAISE button is pressed; the cradle is lowered by gravity alone.

4.5.1 International conformance

The exact specifications of 3-phase machines differ depending on the standard voltage and frequency of 3-phase mains power in the intended country of use.

In locations where 3-phase/~400VAC/50Hz power is standard (NZ/AU/UK/EU and most of Asia) the motor is driven directly by the mains current in 'delta configuration'. In locations where different voltages and frequencies are common (primarily North and South America) an electronic Variable Speed Drive (VSD) is fitted, which modulates the local mains supply and outputs 3-phase/400VAC/50Hz current to the motor in 'star configuration'.

A list of 3-phase power standards used in different countries and territories may be viewed at this web address: <https://www.worldstandards.eu/three-phase-electric-power/>.

-  Connecting the machine to a power supply for which it was not designed may damage the motor and electronic components. Consult an electrician if you are unsure.

4.5.2 Appliance inlet 0790050174

3-phase machines are fitted with an IP66-rated appliance inlet, allowing them to be operated with a 3-phase extension lead. Depending on the power available in your location, the plug may need to be rewired by an electrician for the machine to operate correctly.

-  If the phase wires in the wall socket or extension lead are configured incorrectly, the 3-phase motor may turn in the reverse direction. Although this does not damage the machine, the cradle will not lift. To change the motor direction, swap over any two of the phase wires in the power plug.

4.5.3 Isolator switch 0210050002

3-phase machines are fitted with an isolator switch on the forward side of the powerpack cover. This isolates the electrical systems from the power supply and should be turned OFF if the machine is to be placed in storage, or if the powerpack cover needs to be removed.

-  The isolator switch must be turned OFF before removing the powerpack cover.

4.5.4 Transformer NZ/AU/UK/EU 0250050123

3-phase machines are fitted with a transformer which outputs 24VDC current to the control systems. The input voltage and frequency are specified to suit standard 3-phase mains power in the intended country of use.

4.6 Electrical System (1-phase mains)

 If you do not operate a 1-phase mains machine, please disregard this section.

Machines powered by 1-phase mains electricity are generally the same as other models, but are fitted with an electronic Variable Speed Drive (VSD), which operates a 3-phase 2-pole electric motor driving the hydraulic pump. The control voltage is 24VDC.

The motor only runs when the RAISE button is pressed; the cradle is lowered by gravity alone.

4.6.1 International conformance

The exact specifications of 1-phase machines differ depending on the standard voltage and frequency of 1-phase mains power in the intended country of use. Both the transformer (§4.6.4) and VSD (§4.6.5) are specified to suit local norms.

A list of 1-phase power standards used in different countries and territories may be viewed at this web address: <https://www.worldstandards.eu/electricity/plug-voltage-by-country/>.

 Connecting the machine to a power supply for which it was not designed may damage the motor and electronic components. Consult an electrician if you are unsure.

4.6.2 Appliance inlet NZ/AU 0790050272

1-phase machines are fitted with an IP66-rated appliance inlet, allowing them to be operated with a regular 1-phase extension lead.

4.6.3 Isolator switch 0210050002

1-phase machines are fitted with an isolator switch on the forward side of the powerpack cover. This isolates the electrical systems from the power supply and should be turned OFF if the machine is to be placed in storage, or if the powerpack cover needs to be removed.

 The isolator switch must be turned OFF before removing the powerpack cover.

4.6.4 Transformer NZ/AU 0250050122

1-phase machines are fitted with a transformer which outputs 24VDC current to the control systems. The input voltage and frequency are specified to suit standard 1-phase mains power in the intended country of use.

4.6.5 Variable Speed Drive

1-phase machines are fitted with an electronic Variable Speed Drive (VSD), which outputs 3-phase/400VAC/50Hz current to the motor in 'star configuration'. The VSD input voltage and frequency are specified to suit standard 1-phase mains power in the intended country of use.

The VSD has many parameters that can be set to suit specific applications. They can be modified or calibrated by a PC that has the appropriate program and cable drivers loaded.

 A joystick controller can be provided with the VSD, allowing progressive control over the lifting speed – see §3.3.4.

 Residual voltages may be retained in the VSD inverter after it has been disconnected from the power supply. Use extreme caution when servicing electrical components.

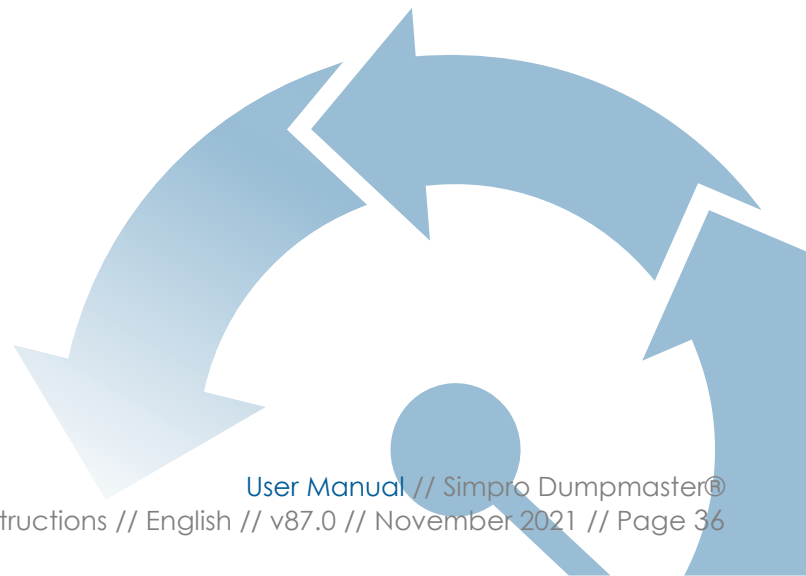

4.7 Hydraulic System

4.7.1 Powerpack 24VDC 1.0cc 0940090001 415VAC 0.75cc 0940090006 415VAC 1.2cc 0940090007

The hydraulic powerpack is supplied as a complete unit. The motor, pump, oil tank, and all control valves are mounted into the centre manifold.

4.7.2 Control valves

The hydraulic system has four primary control valves:

4.7.2.1 Check valve

This is a one-way valve which prevents oil from flowing back through the pump when the motor is stopped.

4.7.2.2 Pressure-relief valve

This is a spring-loaded valve which allows oil to flow back into the reservoir when the hydraulic pressure exceeds its rated limit – usually from lifting an overweight bin, or from operating the machine when the cradle is already at the top of the cycle.

4.7.2.3 Lowering valve

This is a solenoid-operated valve which opens when the LOWER button is pressed and allows oil to flow back to the reservoir, lowering the cradle.

4.7.2.4 Lowering-speed valve

This is a pressure-compensating valve which limits the maximum flow rate of oil passing back to the reservoir through the lowering valve – thus regulating the descent speed of the cradle (regardless of the weight of the bin).

4.7.3 Lift ram DM1200-1800 0330090003



The lift ram is a single-acting displacement type, very robust and reliable, but easy to maintain should the need arise. Hydraulic lines run from the powerpack to the lift ram.

4.7.4 Hydraulic fluid

The hydraulic system is designed to use mineral oil-based fluid with a viscosity grade of 22 (ISO VG22). Fluid with a higher viscosity grade may be used, but this will reduce the lowering speed of the cradle and increase the likelihood of jams.

The hydraulic fluid should have physical lubricating and chemical properties as specified by:

- Mineral Oil Based Hydraulic Fluids HL (DIN 51524 part 1)
- Mineral Oil Based Hydraulic Fluids HL P (DIN 51524 part 2)

 Ensure the cradle is completely lowered before replacing the hydraulic fluid.
 The hydraulic reservoir has markings showing the recommended fill level. Do not fill beyond this level unless specifically instructed by the manufacturer.

4.7.5 Maintenance

After every 12 months of operation the hydraulic fluid should be drained and replaced, as per specifications in §4.7.4. The intake suction-filter and the lowering valve should also be removed and cleaned at this time.

 See §6 for other scheduled preventative maintenance tasks.

4.7.6 Hydraulic system schematic

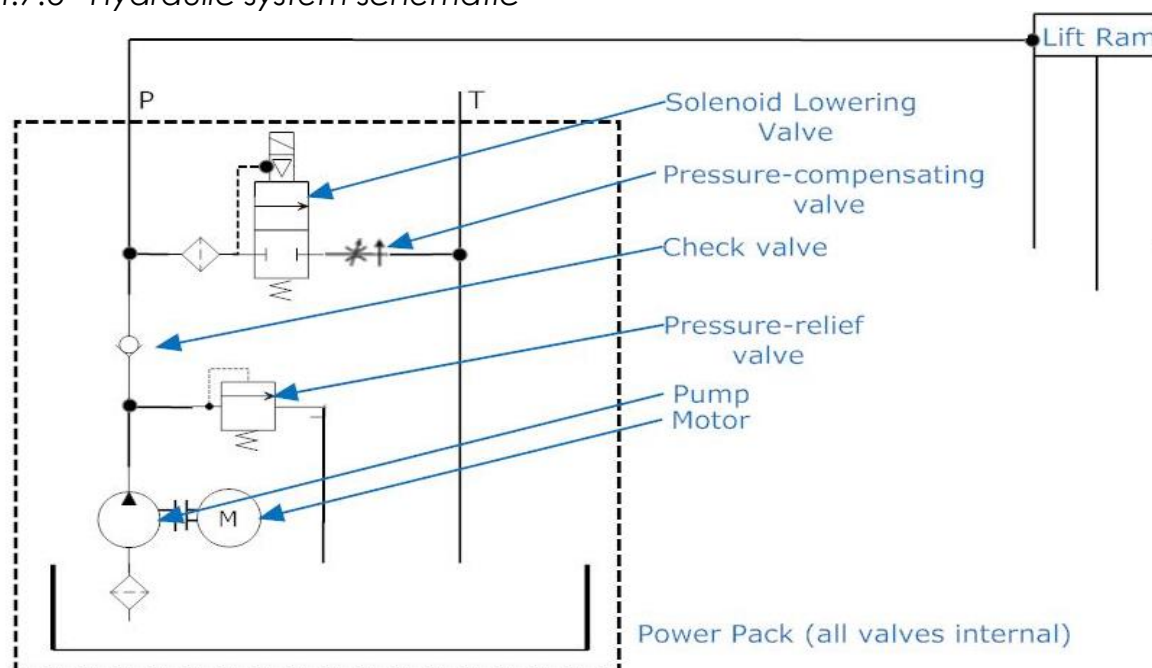

4.8 Safety door and interlock

4.8.1 Standard safety door (side-hinge) 0140020270

The standard Dumpmaster is fitted with a single side-hinge safety door, consisting of a steel tube frame with 25x25x2mm wire mesh guarding. This door is very simple and robust, but will benefit from servicing every 12 months as follows:

1. Lightly lubricate the door pivot points with silicone spray.
2. Check the door safety interlock to ensure it works as intended, as follows:
 - a. Raise the cradle off the ground slightly and try to open the door. If it can open, the switch operated by the cradle may need adjusting or replacing. Contact your agent for instructions.
 - b. Open the door, then press the RAISE and LOWER buttons to verify that the machine does not run. If it does, contact your agent for instructions.
3. Check that all fixings are tight.

4.8.2 Custom safety door (swing-up)

Some custom Dumpmaster models are fitted with a swing-up safety door, consisting of a steel tube frame with wire mesh or sheet-metal guarding, supported by two gas struts. This type of door takes up a minimum of space, but has several moving parts and will benefit from annual servicing as follows:



1. Lubricate the arm pivot points with silicone spray (both ends of all four arms).
2. Check the safety door interlocks to ensure they work as intended:
 - a. Raise the cradle 100mm off the ground and try to open the safety door. If it can open, the cradle-position sensor and/or the door interlocks may need adjusting or replacing. Contact your agent for instructions.
 - a. Open the door, then press the RAISE and LOWER buttons to verify that the machine is now disabled. If it is not, contact your agent for instructions.

3. Ensure the retainer caps on the arm pivot bars are in place, and all fixings are tight.
4. The gas struts are designed to balance the weight of the door throughout its travel, and hold it open. Over time, the gas in the struts can leak out, resulting in reduced lifting force. If the struts do not hold the door open, they may need to be replaced.

4.8.3 Safety door interlock Idec Interlock 0790050408 Idec Cable 0790050410

The standard Dumpmaster safety door is fitted with a solenoid-operated safety interlock. The interlock is an Idec model HS5E-D4403-G or HS5E-F4403-G, 'power-to-unlock' type, with four internal contacts which are used to determine whether the door is closed and locked.

4.8.3.1 Interlock manual override

-  This work should only be carried out by a qualified technician.
-  The interlock Override Key should be stored in a location only accessible to supervisors and technical staff.



All routine cleaning and maintenance on the Dumpmaster should be conducted with the cradle in the lowered position. If for any reason the interior of the safety cage needs to be accessed **while the cradle is raised**, the interlock(s) can be manually disabled by carrying out the following procedure:

1. With the cradle fully lowered, open the safety door.
2. Insert the supplied yellow Override Key into the triangular cam on the door interlock, and turn it to the



UNLOCK position. **The door can now be opened even while the cradle is raised.**

- On machines with a standard control system, the safety door will now function as a switch – the cradle cannot be moved while the door is open, but can still operate while the door is shut.
 - On machines with a PI(d) or PI(e) safety-monitored control system, the system will enter SAFE MODE – the machine is completely disabled, and the cradle cannot be moved until the door is closed, the interlock is re-enabled, and the system is reset.
3. Shut the safety door and raise the cradle to the desired position; then open the door and carry out internal cleaning or maintenance as required.
 4. Once the work is complete, use the Override Key to turn the interlock cam back to the LOCK position.
 5. Remove the Override Key and **store in a safe location.**
 6. Shut the safety door and fully test the machine and all safety functions before returning to service. If the machine is fitted with a PI(d) or PI(e) safety-monitored control system, press the blue RESET button for two seconds to test and reset the safety functions.

-  Do not open the safety door with the Override Key inserted but not fully turned (less than 90°) as this may damage the interlock or cause operational failures.
-  Do not apply excessive force to the Override Key or the interlock components.
-  Do not leave the Override Key inserted in the interlock during normal operations.

4.8.3.2 Interlock specifications

A summary of the interlock specifications is included below. The complete Idec user manual can be downloaded from the following link: <https://goo.gl/iafPol>.

HS5E Safety Door Lock Switches

Small safety switch with four poles and solenoid.

Ideal for applications in small spaces.

- Compact body. 35 × 40 × 146 mm.
- Four-pole internal switches.
- Gold-plated contacts.
- Spring lock and solenoid lock types are available.
- The head orientation can be rotated, allowing 8 different actuator entries.
- A metal entry slot ensures the high durability.
- An actuator with rubber cushions alleviates the impact of actuator entry into the slot.
- The locking strength is 1000N minimum (GS-ET-19).
- Integral cable design minimizes wiring, preventing wiring mistakes.
- LED pilot light indicates the solenoid status.
- RoHS directive compliant.
- Degree of protection: IP67 (IEC60529)
- NC contacts are of direct opening action (IEC/EN60947-5-1).
- Proprietary actuators prevent unauthorized opening (ISO14119, EN1088).
- Double insulation structure.

Spring Lock Type

- Automatically locks the actuator without power applied to the solenoid.
- After the machine stops, unlocking is completed by the solenoid, providing high safety features.
- Manual unlocking is possible in the event of power failure or maintenance.

Solenoid Lock Type

- The actuator is locked when energized.
- The actuator is unlocked when de-energized.



Ratings

• Contact Ratings

Rated Insulation Voltage (Ui) (Note 1)		250V (between LED or solenoid and ground; 30V)		
Rated Thermal Current (Ith)		2.5A		
Rated Voltage (Ue)		30V	125V	250V
Rated Current (Ie) (Note 2)	AC	Resistive load (AC-12)	—	2A 1A
		Inductive Load (AC-15)	—	1A 0.5A
	DC	Resistive load (DC-12)	2A	0.4A 0.2A
		Inductive Load (DC-13)	1A	0.22A 0.1A

• Minimum applicable load (reference value): 3V AC/DC, 5 mA

Note 1: UL rating: 125V

Note 2: TUV, BG rating: AC-15, 0.5A/250V, DC-13, 0.22A/125V

UL, c-UL rating: Pilot duty AC 0.5A/125V, Pilot duty DC 0.22A/125V

• Solenoid

Locking Mechanism	Spring Lock Type	Solenoid Lock Type
Rated Voltage	24V DC	
Rated Current	266 mA (initial value)	
Coil Resistance	90Ω (at 20°C)	
Pickup Voltage	Rated voltage × 85% maximum (at 20°C)	
Dropout Voltage	Rated voltage × 10% minimum (at 20°C)	
Maximum Continuous Applicable Voltage	Rated voltage × 110%	
Maximum Continuous Applicable Time	Continuous	
Insulation Class	Class F	

• Pilot Light

Rated Voltage	24V DC
Rated Current	10 mA
Light Source	LED
Light Color	Green

Specifications

Applicable Standards	ISO14119 EN60947-5-1 (TUV approval) GS-ET-19 (BG approval) CSA C22.2, No. 14 (c-UL recognized)	IEC60947-5-1 EN1088 (TUV approval) UL508 (UL recognized)
Operating Temperature	-25 to 50°C (no freezing)	
Relative Humidity	45 to 85% (no condensation)	
Storage Temperature	-40 to +80°C (no freezing)	
Pollution Degree	3	
Impulse Withstand Voltage	2.5 kV (between LED, solenoid and grounding; 0.5 kV)	
Insulation Resistance (500V DC megger)	Between live and dead metal parts: 100 MΩ minimum Between live metal part and ground: 100 MΩ minimum Between live metal parts: 100 MΩ minimum Between terminals of the same pole: 100 MΩ minimum	
Electric Shock Protection	Class II (IEC61140)	
Degree of Protection	IP67 (IEC60529)	
Shock Resistance	Operating extremes: 100 m/s ² Damage limits: 1000 m/s ²	
Vibration Resistance	Operating extremes: 10 to 55 Hz, amplitude 0.35 mm minimum Damage limits: 30 Hz, amplitude 1.5 mm minimum	
Actuator Operating Speed	0.05 to 1.0 m/s	
Direct Opening Travel	Actuator HSSZ-A51: 11 mm minimum Actuator HSSZ-A51A/A52/A52A/A53/A55: 12 mm minimum	
Direct Opening Force	80N minimum	
Tensile Strength when Locked	1000N minimum (GS-ET-19)	
Operating Frequency	900 operations per hour	
Mechanical Life	1,000,000 operations minimum (GS-ET-19)	
Electrical Life	100,000 operations minimum (operating frequency 900 operations per hour, load AC-12, 250V, 1A)	
Conditional Short-circuit Current	50A (250V) (Use 250V/10A fast acting type fuse for short-circuit protection.)	
Cable	UL2464, No. 21 AWG (8-core: 0.5 mm ² or equivalent/core)	
Cable Diameter	ø7.6 mm	
Weight (approx.)	400g (HS5E-***01)	

4.9 Safety-Monitoring System (CAT3/CAT4 only)

⚠️ If you do not operate a machine with a safety-monitored control system to achieve ISO 13849-1 or AS/NZS 4024 PL(d) or PL(e), please disregard this section.

Machines with a CAT3 or CAT4 safety architecture are fitted with a Rockwell CR-30 Safety Relay ⁰⁹⁶⁰⁰⁵⁰⁰²⁷ to monitor the safety systems. The Safety Relay continuously monitors the status of the Emergency Stop contacts, door lock, cradle-lowered sensor, and any other installed sensors.

The Safety Relay goes into SAFE MODE:

1. If any fault is detected;
2. Whenever the door is unlocked or opened;
3. Whenever the Emergency Stop is pressed;
4. Whenever the tipper is moved away from the 'safe' position (optional).

Whenever the machine is in SAFE MODE the blue RESET lamp glows, and the machine must be 'reset' before it can be operated. To reset the machine, first ensure the door is correctly closed and locked, the Emergency Stop is released, and the tipper is in the correct position. Next, press and hold the RESET button for about two seconds. A diagnostic test is run on the machine, and if all safety functions are operating correctly the lamp will go out when the button is released, indicating a successful reset. If a fault has been detected in any of the safety equipment or connections, the machine will not reset and cannot be operated – the RESET lamp will continue to glow.

This documentation is to assist an engineer or electrician to find and repair any fault preventing the system from resetting. Most faults can be traced from the LEDs on the CR30 safety relay itself; some locks and sensors also have LEDs to assist in troubleshooting.

4.9.1 440C-CR30 Safety Relay

The 440C-CR30-22BBB (CR30) relay is a software-configurable safety relay. This device is intended to be part of the safety-related control system of a machine. The CR30 safety relay is based on the Micro800 platform and must be configured using a personal computer (PC) with the Allen-Bradley® Connected Components Workbench software.

The housing is red to signify it as a safety device and to distinguish it from the grey-coloured standard controllers.

The CR30 safety relay accommodates up to 24 safety monitoring functions. Examples of safety monitoring functions are single channel input, dual channel input, two hand control, reset, and feedback. It has 22 embedded safety rated inputs and outputs and accepts up to two plug-in modules, each of which has



four standard inputs and four standard outputs.

The CR30 safety relay can be configured to accept two single-wire safety inputs and to provide two single-wire safety outputs. This feature allows the CR30 safety relay to be an integral part of an extensive machine safeguarding system.

There are 10 Input LEDs, 5 General Status LEDs, and 6 Output LEDs. These can help identify faults and do basic troubleshooting. The input and output LEDs are set up when designing the program. A print-out of the program function and what each LED refers to should be provided with each machine.

The PWR and RUN LEDs should be illuminated when the system is ready for use. If the FAULT or LOCK LEDs are showing, try cycling the power. If the LEDs remain on, a computer with the *Connected Components Workbench* software must be connected to identify and resolve the problem.

4.9.2 Troubleshooting

Faults in the CR30 relay fall into two categories: recoverable faults, and non-recoverable faults. Non-recoverable faults require power cycling to recover after the fault is corrected. Recoverable faults can be cleared by eliminating the cause of the fault and cycling the inputs associated with the fault. The output that is connected to an input with that fault is switched off. The other outputs, which are not affected by the fault, will continue to work.

Examples of recoverable faults include:

- SMF Faults
- Cross loop
- Simultaneity Faults
- Reset button fault
- Muting: Synchronization time exceed
- Muting time exceeded
- Sequence fault

4.9.3 Configuration

The CR30 is software configurable using the Rockwell Automation *Connected Components Workbench* (CCW) software. CCW is a set of collaborative tools supporting the CR30 safety relays. It is used to configure the CR30, program the Micro 800 controllers, and configure many PowerFlex drives and PanelView graphic display terminals.

The CCW software is free and can be downloaded from the Rockwell website at the following link: goo.gl/7wgl1d. To help you configure your relay through the Connected Components Workbench software, you can refer to the Connected Components Workbench Online Help (provided with the software).

The CR30 has a USB interface for connection to a personal computer for configuration. Use a standard USB A Male to B Male cable for connecting to the relay.

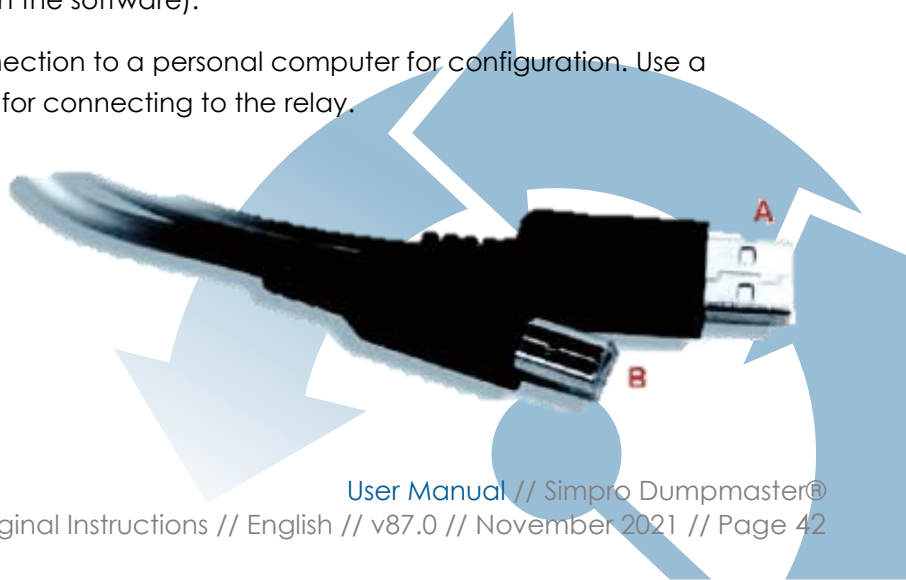

5. Assembly, Handling, Transport & Storage

5.1 Assembly

The Dumpmaster is usually delivered fully assembled. However, in some cases guarding panels may be removed to minimise volume for shipping. Assembly instructions can be viewed at the following link: <https://support.simpro.world/help/dumpmaster-assembly-guide>.

⚠ In some cases, a sealed 'transit plug' is fitted to the hydraulic reservoir to prevent oil leaks during shipping. This must be replaced with the supplied 'breather plug' before the machine is operated, or the reservoir may be damaged.

5.2 Moving

When the machine is standing upright it may be easily moved on its castor wheels, using the two grab-handles provided. To ensure stability, the cradle should be positioned 100mm off the ground when moving.

📌 An accessory is available from Simpro which enables a directional lock on the castor wheels. This can make the machine easier to manoeuvre on sloping ground.

⚠ Extra care should be taken when moving the machine on sloping ground.

5.3 Lifting

If the machine needs to be lifted for any reason, carry out the following procedure:

1. Check that the lifting equipment is in good condition and rated to lift at least 500kg.
2. Affix a lifting sling or chain around the top frame cross-member (or to the lifting lugs if provided).
3. Use one person to operate the lifting equipment, and at least one other person to watch for obstructions and hold the machine steady if required.
4. Lift, move and lower the machine into place, ensuring it remains upright at all times.

⚠ Standard Dumpmaster machines weigh between 200kg and 300kg. Always verify the weight of the machine on the rating plate, and check that the lifting equipment to be used has sufficient capacity.

⚠ Never stand or reach underneath the machine while it is being lifted.

5.4 Transport

Carry out the following procedure when the machine needs to be transported:

1. Lower the cradle, apply both brakes and turn the isolator switch OFF.

2. Tie the cradle to the bottom frame cross-member with plastic strapping or similar. This will maintain positive tension on the chains during transit, preventing them from derailing from the chain guide and roller at the top of the mast.

 If the chains do become derailed for any reason, a screwdriver can be used to remove the chain covers at the top of the mast, providing access to the chain guide and roller.

3. Use lifting equipment to lie the machine onto its front (tipping) face on a wooden pallet, and securely strap it into place.
4. Use a 1-tonne forklift to load the pallet onto the deck of the truck.
5. Tie the machine into position using marked tie-down points and stops rated to at least 1000kg, ensuring it is fastened against lateral forces from any direction.

 Never lie the machine onto its sides or back (safety door) as this may cause hydraulic fluid leaks and/or damage to the guarding.

5.5 Storage

If the machine is not to be used for a period of two months or more, it should be stored in a clean, dry place with good ventilation, at temperatures not below 0°C. Before placing the machine into storage, carry out the following procedures:

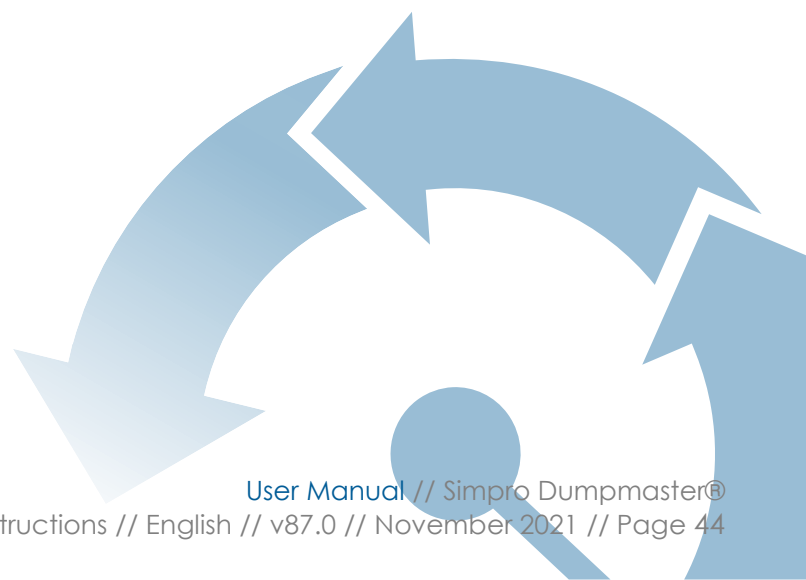

1. Clean the machine thoroughly as per §4.2.
2. Carry out two full tipping cycles, then lower the cradle to the ground.
3. Apply a thin layer of silicone lubricant to exposed surfaces of moving parts.
4. Charge the batteries (if fitted) and lubricate the electrical contacts.
5. Turn the isolator switch OFF.
6. Remove the key and store it in a safe place.



6. Preventative Maintenance Inspections

It is recommended to conduct regular preventative maintenance inspections (PMIs) of the Dumpmaster. This helps to ensure operator safety and extend the service life of the machine.

The PMI schedule is divided into three parts: weekly, monthly, and annual inspections. The PMI procedures are described in the following pages, with logs for recording the results.

-  Simpro strongly recommends that safety inspections are carried out according to the schedule described in this section.
-  Operators should immediately stop using the machine and request an inspection if any fault or abnormal operation is observed.

6.1 Pre-inspection checklist

1. Wear suitable Personal Protective Equipment (PPE), including safety boots and protective eyewear.
2. Check that there are no ignition sources nearby.
3. Lower the cradle and remove bin.
4. Turn off the key switch and unplug the charging lead.
5. Remove the powerpack cover.
6. Clean the powerpack and electric circuitry with compressed air.
7. Always use height safety equipment when servicing elevated areas.

6.2 Weekly inspection

The following inspection should be carried out every week, and the results recorded in the log on the following page.

Weekly Inspection Checklist			
Category	No.	Item	Check
General	1	Entire machine	Conduct a complete tipping cycle and check for any faults or abnormal behaviour.
Safety systems	2	Door interlock actuator	Check that the actuator is securely attached to the door with security screws, and enters the interlock freely and smoothly, without force. Check that the actuator locks the door while the cradle is raised above 100mm.
Mechanical systems	3	Inside masts	If the tipping motion appears to be jerky or inconsistent, spray a small amount of silicone lubricant inside the masts and on the roller pivot arm(s) to minimise friction.
	4	Roller pivot arm(s)	

6.3 Monthly inspection

The following inspection should be carried out every month, and the results recorded in the log on the following page.

Monthly Inspection Checklist			
Category	No.	Item	Check
General	1	Entire machine	Conduct a complete tipping cycle and check for any faults or abnormal behaviour.
Hydraulic systems	2	Hydraulic ram	Check there are no oil leaks.
	3	Oil reservoir	Check the level of hydraulic fluid and if necessary, top-up in accordance with §4.7.4.
Electrical systems	4	Mains power lead (if fitted)	Check that the lead is in good condition.
Safety systems	5	Door interlock actuator	Check that the actuator is securely attached to the door with security screws, and enters the interlock freely and smoothly, without force. Check that the actuator locks the door while the cradle is raised above 100mm.
Mechanical systems	6	Inside masts	Lightly lubricate with silicone spray.
	7	Roller arm(s)	Lightly lubricate with silicone spray.
	8	Door hinges	Lightly lubricate with silicone spray.
	9	Cradle axle	Lightly lubricate with silicone spray.
	10	Castor wheels (if fitted)	Check that the castor wheels are running smoothly and the brakes working correctly.

Date	Service Person	Location	Checks complete	Notes on repairs or maintenance required	Parts and materials used

6.4 Annual inspection

The following inspection should be carried out every 12 months, and the results recorded in the log on the following page.







































Annual Inspection Checklist			
Category	No.	Item	Check
General	1	Entire machine	Conduct a complete tipping cycle and check for any faults or abnormal behaviour.
Hydraulic systems	2	Hydraulic ram	Check there are no oil leaks.
	3	Oil reservoir	Drain and replace the hydraulic fluid in accordance with §4.7.4. Clean the intake suction-filter.
	4	Lowering valve	Remove and clean.
Electrical systems	5	Mains power lead (if fitted)	Check that the lead is in good condition.
Safety systems	6	Door interlock actuator	Check that the actuator is securely attached to the door with security screws, and enters the interlock freely and smoothly, without force. Check that the actuator locks the door while the cradle is raised above 100mm.
	7	Safety labels and markings	Check that all warnings labels, guides etc are attached and clearly legible.
Mechanical systems	8	Lifting chains	Check the length and condition of the lifting chains. If the length is outside the allowable tolerance, or there are signs of corrosion or wear, they should be replaced. Lightly lubricate with silicone spray.
	9	Ram rollers	Lightly lubricate with silicone spray.
	10	Follower rollers	Lightly lubricate with silicone spray.
	11	Inside masts	Lightly lubricate with silicone spray.
	12	Roller pivot arm(s)	Lightly lubricate with silicone spray.
	13	Door hinges	Lightly lubricate with silicone spray.
	14	Cradle axle	Lightly lubricate with silicone spray.
	15	Castor wheels (if fitted)	Check that the castor wheels are running smoothly and the brakes working correctly.

Date	Service Person	Location	Checks complete	Notes on repairs or maintenance required	Parts and materials used

7. Spare Parts

The following table includes the most common Dumpmaster spare parts as at the time of publication. Additional parts, accessories and prices may be viewed at the following web address: <https://simpro.world/dumpmaster-spare-parts>

 Where a part has been introduced or discontinued, the Date Of Manufacture (DOM) period is noted in brackets. The DOM can usually be found on the machine's rating plate.

Ref.	Partcode	Description
1	 0640200064	Top Roller
2	 0140110003	SS304 axle for top roller
3	 0140120004	Chain Guide, moulded, for top frame
4	 0330090003	Ram, 1in x 1045mm stroke, no rollers (DM1200-1800) (DOM 2019-)
5	 090090006	Ram Seal, 1in x 1¼in x ¼in (PU + NBR O-ring)
6	 0140120002	Ram-End Roller, nylon
7	 0790050373	Key-switch, 2-position, stay-put, with 2 x N/O contact blocks
8	 0790050067	Voltmeter, 12/24VDC, blue digital readout (DOM 2017-)
9	 0790050454	Up/Down Switch, dual push-button, booted, with 2x N/O contact blocks
10	 0250050004	Battery, 12V/20Ah, VRLA, deep-cycle gel (2x batteries per machine) (descriptor for local sourcing "12V/21Ah VRLA deep-cycle battery")
11	 0210050002	Isolator Switch, configurable, 16A/20A (DOM 2016-)
12	 0880050015	Motor Solenoid, 24V/200A, round silver (battery only) (DOM 2015-)
13	 0390050006	Battery Charger, 160W/24V/6A, universal (battery only) (DOM 2015-)
-	 0790050374	Circuit Breaker, 75A, auto-reset, E97 (battery only) (DOM 2019-)
14	 0880050023	Motor, 800W/24VDC (battery only) (DOM 2015-)
-	 0250050042	Contactora, 24vdc coil, EBS1C-P0910 (3-ph only)
-	 0250050003	Thermal Overload Relay 2.5-4A (3-ph only)
14	 0880050035	Motor, 3-ph 2 Pole 1.1kW 400V 71-Frame (3-ph only)
15	 0250090067	Lowering Valve Coil, 24VDC (DOM 2015-)
16	 0940090001	Powerpack, 24VDC, 1.0cc pump, 4L Steel tank (battery) (DOM 2015-)
16	 0940090006	Powerpack, 3-ph 400V, 0.75cc pump, 4L Steel tank (3-phase)
17	 0250040072	Castor, 100mm, ZP frame, TPR wheel, no brake
18	 0250040076	Castor, 100mm, ZP frame, TPR wheel, total brake
19	 0140020088	U-bar, standard
20	 0760040041	Side Guard Panels, handed pair, 25x25 mesh, complete with bungs
21	 0140020270	Safety Door, right-hung, 25x25 mesh, complete with bungs
22	 0790050408	Idec Solenoid Door Lock, 24VDC, plug-n-play (DOM 2019-)
22	 0790050410	Idec Cable Kit, 5m, plug-n-play, complete with gland (DOM 2019-)
23	 0250050065	Idec Actuator, rubber-cushioned (DOM 2016-)
24	 0760120050	Idec Mounting Bracket, 8mm thick, waterjet cut (DOM 2016-)
25	 0400020015	Cradle, Type-E complete, 3mm PGI, standard DM (DOM 2015-)
26	 0640200005	Roller Arm, zinc-plated, standard DM
27	 0090120000	Follower Roller, ø50mm x 35mm wide, unbushed
28	 0140120000	Follower Roller Bush, 12x16x36mm
29	 0640200057	Sliding Plate, zinc-plated, standard DM
30	 0140120007	Mast Rollers, machined, standard DM
31	 0400020168	Bin Catch, universal, 3.0mm PGI, suits EN840 80L/120L/240L (DOM 2017-)
32	 0400200000	Top Roller Arm Axle, drilled and zinc-plated, standard DM
33	 0000000002	Main Cradle Axle, drilled and zinc-plated, standard DM

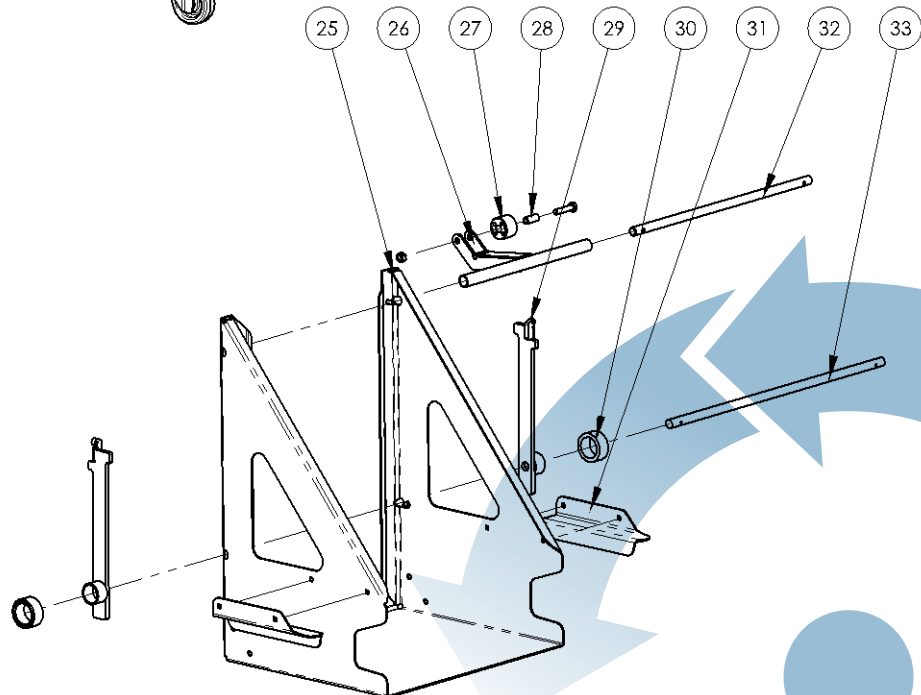
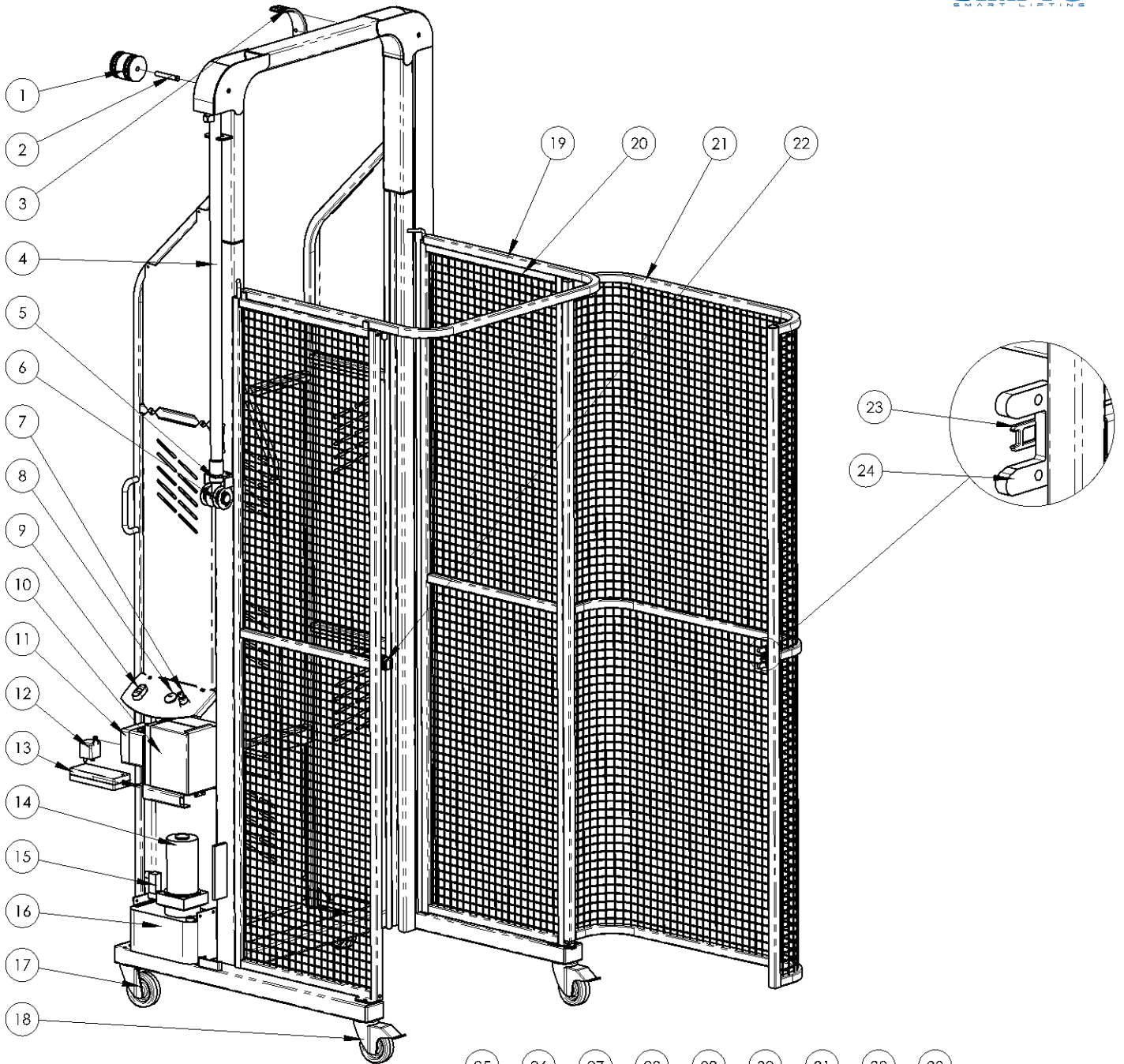

8. Warranty

8.1 Definitions

1. "Simpro" means Simpro Handling Equipment Limited, [New Zealand Registered Company No. 1827916](#).
2. "Agent" means a person or company authorized by Simpro to sell a Product.
3. "Service Agent" means a person or company authorized by Simpro to repair a Product.
4. "End User" means the first purchaser of a Product from a Sales Agent authorised by Simpro to sell the Product.
5. "Warranty" means the commitment that Simpro has to guarantee the workmanship and componentry to any End User of Products manufactured and sold by Simpro.
6. "Warranty Claim" means an application from an Agent to Simpro to be reimbursed for expenses relating to repairs done to remedy a fault with a Simpro Product.
7. "Warranty Period" means the length of time that Simpro undertakes to guarantee a Product.
8. "Back to Base" means that the costs associated with the transporting of a Product between the Service Agent and the End User is the End Users responsibility.
9. "Standard Products" means any Product displayed as a standard product on the Simpro website, <https://simpro.world/>.
10. "Part" and "Parts" refer to components of a Product.
11. "Minor Fault" means a fault or defect that requires less than one hour to rectify
12. "Instruction Handbook" means a document so titled that provides brief information and guidance on the operation of the Product for commonly performed functions.
13. "Service Manual" means a document so titled that provides comprehensive information and guidance for service, repairs and maintenance.
14. "Warranty Registration Process" means the process of an End User registering their product with Simpro. This may be done using the web form here: <https://simpro.world/support/warranty-registration>
15. "Application for Warranty Consideration Form" means the system used to file a Warranty Claim with Simpro. This may be done using the web form here: <https://simpro.world/support/warranty-claim>.

8.2 Coverage

1. Simpro provides a 12 month Back to Base Warranty on all Standard Products unless alternative terms have been agreed to in writing.
2. The Warranty terms and conditions on custom-built and non-standard machines are generally specified on quotations, and placing an order implies acceptance of the Warranty terms. If no specific Warranty details have been provided, the standard terms and conditions will apply.
3. The 12-month Warranty period shall be taken from the date the machine first leaves the Agent's premises, whether sold or just supplied for trial. The Agent shall keep accurate records of the date of all machine trials, sales, etc.
4. Simpro will, at its option, repair or replace any items that fail or prove defective within the Warranty period.
5. Simpro's liability under the terms of this Warranty shall be limited to remedying any fault that occurs on machines it has manufactured or supplied, and shall not cover any consequential loss or damage.
6. The Warranty on batteries is for 12 months only, and is distinct from the warranty on the rest of the machine. Information on maximising battery life is provided in the User Manual.

8.3 Exclusions

1. Simpro will not recognise a Warranty Claim against a machine where payment to Simpro for that machine is outstanding. If a Warranty Claim is made before payment is due, the full payment must be made on the due date. The Warranty Claim, if accepted, will be credited at a later date.
2. Warranty Claims may not be recognized unless the [Warranty Registration Process](#) has been completed. If not done at the time of sale, this should be done at the time of the Warranty Claim. If warranty registration has not been completed, proof of purchase may be required.

3. Damage caused or contributed to by misuse, abuse, accident, unauthorised repairs or modifications, or failure to use the machine in accordance with instructions is specifically excluded.
4. Travelling time and mileage are specifically excluded from the Simpro warranty coverage. However, under certain circumstances Simpro at its discretion may contribute to these costs. Authorisation must be obtained from Simpro prior to any such Warranty Claim. This does not prohibit an Agent offering more extensive Warranty cover, outside of this Warranty, as negotiated between the Agent and the End User.

8.4 End User claim procedure

1. Where a fault or breakdown appears to have occurred the End User should, if applicable, first consult the Quick Troubleshooting Guide section of the User Manual provided with each machine, to ascertain the cause of the fault and remedy if possible. This information may also be accessed on the Simpro Support website: <http://support.simpro.world>.
2. If the fault is not able to be remedied, the End User should contact the Agent who sold the machine, and explain as fully as possible the fault, including all relevant factors such as:
 1. Did the fault occur suddenly, or has it been developing over some time?
 2. Was the machine being used at the time?
 3. Is the fault intermittent?
 4. Are the batteries fully charged?
 5. If repair is urgent, or the Agent cannot be contacted, the End User may contact Simpro directly.

8.5 Agent claim-handling procedure

1. Upon receiving notification of a fault, the Service Agent should attempt to determine the cause and a course of action before going to see the machine.
2. The Service Agent should contact Simpro for assistance in identifying the fault, if it is not apparent. This step is important, so that if a site visit is necessary, the correct tools and spare Parts can be taken. It is also important to establish whether there may have been any negligence, misuse or an accident that contributed to or caused the fault.
3. Parts requiring replacement will be supplied by Simpro free of charge; in some cases, it may be necessary to source Parts locally if needed urgently, but Simpro must authorize this if the cost of the item exceeds \$50.00 and is to be charged to Simpro.
4. If the fault is not a Minor Fault, the Agent must notify Simpro and receive authorization to proceed before the repair work is done. Simpro will assist in every way possible, including discussing the problem directly with the End User if necessary, to determine the best method of effecting the repair in the shortest time possible.
5. Upon completion of the repair to an acceptable standard, the Agent shall complete the [Application For Warranty Consideration Form](#) and include copies of any invoices for labour, and any Parts supplied.
6. The cost of Warranty repairs is not to be deducted from any payments due to Simpro, unless Simpro issues a credit note clearly stating the amount and which invoice it relates to.
7. Simpro undertakes to be reasonable in respect of all Warranty repairs undertaken by Agents, but reserves the right to decline payment for:-
 1. Work done or materials replaced that were not authorized in advance by Simpro.
 2. Work not done to an acceptable standard.
 3. Work taking an unduly long time, due (in part or in full) to the lack of knowledge or skill of the serviceman or the Agent. The time allowed for repair work will be based on Simpro's assessment of what a reasonably skilled technician would take. A Service Manual is available on request from Simpro, and all service visits should be conducted with this document at hand.

This warranty shall be interpreted according to the laws of New Zealand and the parties agree to submit to the jurisdiction of the Courts of New Zealand.

9. EC Declaration of Conformity



DECLARATION OF CONFORMITY

ORIGINAL

Business Name and Full Address of Manufacturer

Simpro Handling Equipment Ltd
66 Rangi Road, Takanini 2105
Auckland, New Zealand

Name and Address of Authorised Representative

As above

Name and Address of the Person in Community Authorised to compile the Technical File (if different to above)

Safe Machine Limited
DBH Business Centre, Coxwold Way, Billingham, Tees Valley TS23 4EA UK

Description of product (Commercial Name)

Dumpmaster

Function, Model, Type, Serial Number

Function: Bin Tipper
Type:

Model: Dumpmaster
Serial No:

Standards Used

EN 349 1993, EN 574 1996+A1:200, EN 953 1997, EN ISO 4413 2010, EN ISO 12100 2010,
EN ISO13849-1 2006, EN ISO 13857 2008, EN 60204 2006+A1 2009, EN61000-6-2 2005,
EN61000-6-4 2007

Place of Declaration

66 Rangi Road, Takanini 2105
Auckland, New Zealand

Date of Declaration:

24 February 2018

Declaration

I declare that the machinery fulfils all the relevant provisions of the following Directives:-
Machinery Directive 2006/42/EC, Electromagnetic Compatibility Directive 2004/108/EC.

Person Empowered to Draw Up Declaration

Name: Daniel Craig Currie

Position: Business Development Manager

Signature:



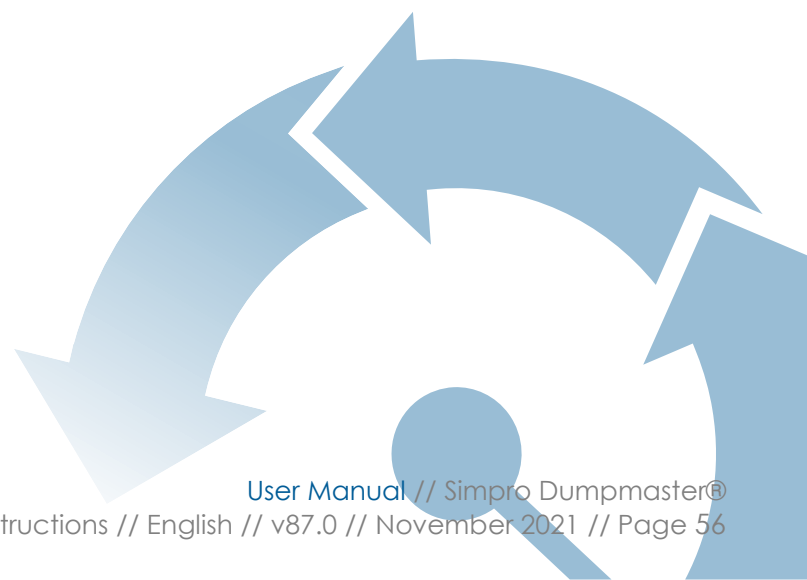

Declaration No: 003

10. Notes



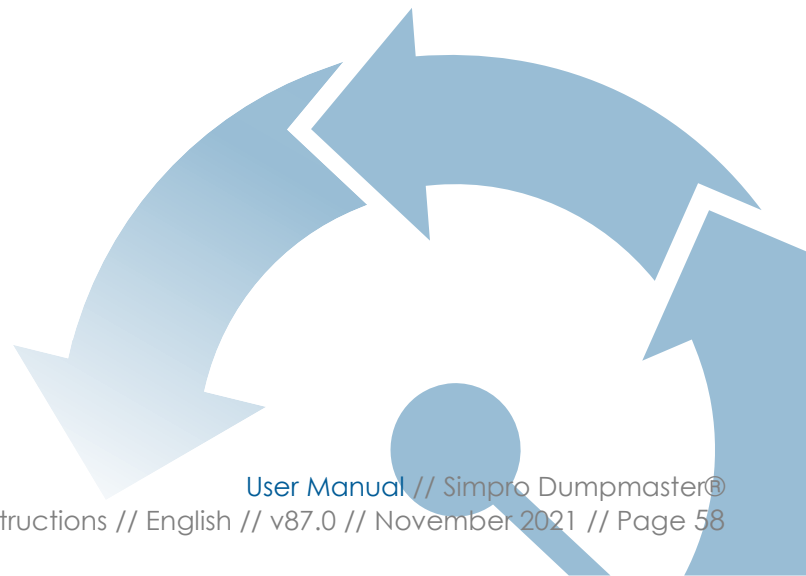



 Simpro has been supplying Smart Lifting solutions for over 30 years. Founded in 1986 as a light engineer, the company has since built a unique position in the supply chain for specialist materials-handling equipment - from bin lifters and crate stackers to Lithium-ion forklifts.

With business activities including design, manufacture, import, export, wholesale and retail, Simpro products now play a quiet role for thousands of companies around the world. Customers range from SMEs to bluechips, operating in sectors as diverse as warehouse logistics, food processing and waste management.

Simpro's OEM products are now sold around the world through a distribution network covering most large economies. The product range continues to evolve thanks to a policy of continuous R&D, new ideas and new partnerships.

Simpro is a family company, based in Auckland and registered with the New Zealand Companies Office as Simpro Handling Equipment Ltd (1827916).

This document may contain intellectual property belonging to Simpro, including patents, trademarks and/or registered designs.

 66 Rangi Road
Takanini 2105
Auckland, New Zealand

 PO Box 74
Takanini 2245
Auckland, New Zealand

 +64 9 634 7445

 sales@simpro.world

 shop.simpro.world

 @simpro.world

 @SimproWorld_Lifters

