



Double Swing Gate Opener User Manual GTR058

Before starting we recommend watching the installation video that can be found at:

richmondau.com/product/gtr058-double-swing-gate-opener/

This video will give a detailed overview of the installation process and will serve as a useful aid during installation.



Instructions must be read before beginning installation. Please follow these instructions carefully, incorrect installation could affect gate operation. If you require more information, please contact your local Richmond Wheel & Castor Co branch.

AU: 1300 474 246 **NZ:** 0800 61 71 81 **International:** +613 9551 2233

For installation or troubleshooting assistance visit richmondau.com/gate-motor-support/

For accessories: please refer to the relevant accessory manuals for instructions on wiring them to the GTR058 motor.

Contents:

General Safety	4
Parts List	5
Technical Specifications	6
Features	7
Gate Arm Installation: Pull to Open (Standard)	
Before you start/Tools Required	9
Gate Preparation	10
Step 1 – Post Bracket Assembly	11
Step 2 - Set the Motor to Manual Mode	13
Step 3 – Positioning the Gate Bracket & Opener	13
Step 4 – Setting the Minimum Clearances	15
Step 5 – Affixing the Gate & Post Brackets	16
Step 6 – Mounting the Control Box	17
Step 7 – Running the Motor Cable	17
Step 8 – Connecting the Gate Arm	18
Step 9 – Adjusting the Travel Limit Switches	19
Programming and Wiring	
Programming Features	20
Pairing Remote Controls	24
Control Board Wiring Diagram	25
Optional Installation: Setting the Gate as Push to Open	
Push to Open Installation Instructions & Wiring	27-30
Troubleshooting	31

For accessories: please refer to the relevant accessory manuals for instructions on wiring them to the GTR058 opener.

Thank you for choosing this swing gate opener. Please read the manual carefully before assembling and using it. Do not leave out the manual if you send this product to a third party. This product complies with the recognised technical standards and safety regulations. Our company has the right to change the instruction without prior notice.

General Safety:













Warning: Incorrect or improper use of this product can cause damage to persons, animals or properties.

- Please ensure that the input voltage to the low voltage power supply used matches with the supply voltage of gate opener (AC240V 50Hz).
- To avoid damaging gas, power or other underground utility lines, contact the relevant authority BEFORE digging.
- All potential hazards and exposed pinch points of the gate must be eliminated or guarded prior to installation of this gate motor.
- Never mount any device that operates the gate motor where the user can reach over, under, around or through the gate to operate the controls. These must be placed at least 1.8m from any moving part of the moving gate.
- Ensure power plug is disconnected from the power socket during installation or maintenance.
- Keep remote control and other control devices out of children's reach, in order to avoid unintentional activation.
- Never allow anyone to hang onto the gate while moving.
- Please ensure a warning sign provided is fitted to the gate.
- If required, install infrared photocells (sold separately) to detect obstructions and prevent injury or damage.
- Instruct all users about the control systems provided and the manual opening operation in case of emergency.
- Ensure that the power cable is connected to a RCD protected power outlet that has been installed by a qualified electrician.
- Do not install the product in an explosive atmosphere or where there is any danger of flooding.
- This product was exclusively designed and manufactured for the use specified in the present documentation. Any other use not specified in this documentation could damage the product and be dangerous.
- Only use original parts for any maintenance or repair operation. Richmond Wheel & Castor Co declines all responsibility with respect to the automation safety and correct operation when other supplier's components are used.
- Do not modify the automation components, unless explicitly authorised by Richmond Wheel & Castor Co.
- The user must avoid any attempt to carry out any works or repairs on the motor, and should always request the assistance of qualified personnel.
- This motor is suitable for use on one swing gates only.
- Anything which is not expressly provided for in these instructions is not allowed and will void warranty.
- Dispose of all packing materials (plastic, cardboard, polystyrene etc.) according to current guidelines. Keep plastic bags and polystyrene out of children's reach.

Please save these instructions for future use.

Parts List:

No.	Picture	Name	Quantity
1		Gate Opener (1 with 1.5m cable, and 1 with 6m cable)	2
2		Control Box	1
3		Remote Controls (Additional remotes can be purchased separately. Part no: GTR058)	2
4		Manual release key (These keys are needed during power outage, keep on hand)	2
5		Post Bracket	4
6		Post Pivot Bracket	2
7		Gate Bracket	2
8		Gate Warning Signage (must be fitted to gate)	4

Hardware		
 ø10 Washer (14 pcs)	 ø8 Washer (2 pcs)	 ø10 lock Washer (14 pcs)
 M10 Nut (14 pcs)	 M8 Nut (2 pcs)	 M10x200 Bolt (8 pcs)
 M10x75 Bolt (4 pcs)	 M10x30 Bolt (2 pcs)	 M8x30 Washer (2 pcs)
 12x40 Clevis Pin (2 pcs)	 12x30 Clevis Pin (2 pcs)	 Hairpin Clip (4 pcs)

Technical Specifications:

Model	GTR058
Input	240V/50Hz
Motor Voltage	24VDC
Power	80W each Gate Opener
Current	3A
Actuator Speed	16mm/s
Max. Actuator Travel	385mm
Max. Weight of Gate	400kgs per gate* (refer to table 1 below)
Max. Width of Gate	5mtrs per gate For dual gates longer than 4mtrs an extension cable is required. 3m (GTR158) and 6m (GTR159) extension cables to suit available.
Ambient Temperature	-20°C~ +50°C (-4°F to 122°F)
Noise	≤60dB
IP Protection Class	IP44
Remote Control Frequency	433.92MHz
Package Weight	18kg

* Refer to table 1

Single Arm - 1 gate opener used per gate

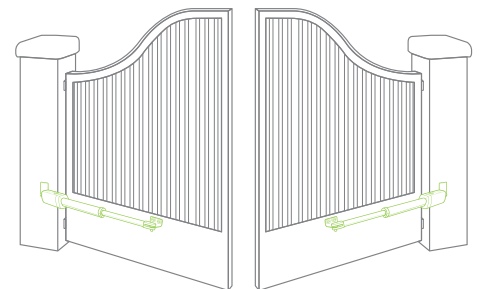
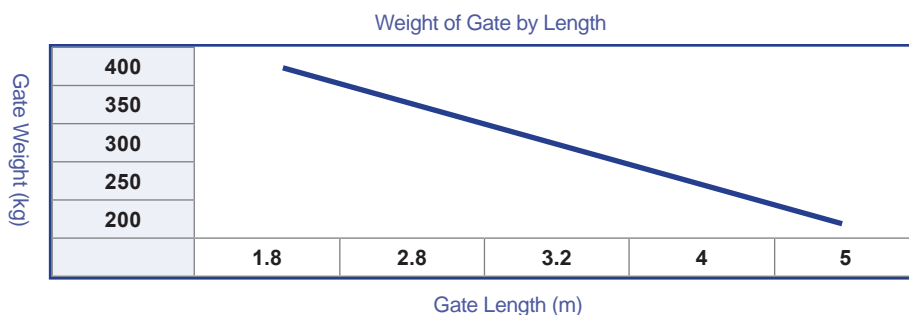

Table 1

Dual Arm - 2 gate openers used on a heavier single gate

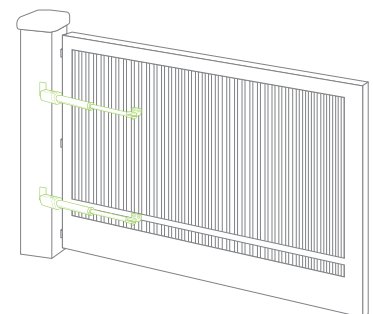
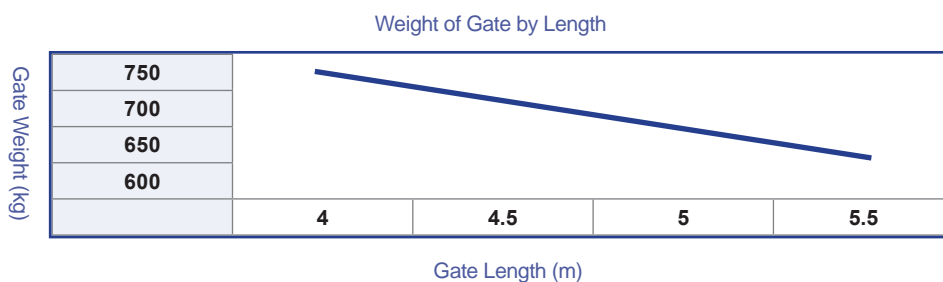

Table 2

Features:

- Soft start and soft stop
- Emergency release key in case of power failure
- Dual/Single gate running mode
- Adjustable opening/closing interval between the Primary and Secondary gate.
- Stop/Reverse in case of obstruction during gate opening/closing.
- Built in adjustable auto-close (0-99 seconds)
- Built in max. Motor running time (MRT) adjustable for multiple safety protection (1-50 seconds)
- Digital display indicates the running situation and setting menu
- Reliable electromagnetism limit for easy adjustment
- Comes with 2x pre-programmed remotes. Additional remotes can be purchased separately.
- Can be equipped with a wide range of accessories, visit our website to see the full range of accessories available: richmondau.com/automatic-gate-openers-hardware/

Gate Arm Installation:

Before you start:

The GTR058 Swing Gate Automation Kits are suitable for gates up to 400kg per arm not exceeding 5m in length. Refer to Table 1 (page 6) to verify that your gate will be suitable. The motor arm uses a worm gear actuator to move your gate. The swing gate openers must be installed on the inside of the property.

The control box comes with a 1.5m 10 amp 3 pin power cable. This should be plugged into an appropriate weatherproof power outlet, which must be installed by a qualified electrician. Do not extend the power cable. Make sure the power cord is protected from flooding, tripping and any other damage. If in any doubt, we recommend shielding all cables with electrical conduit.

Is the gate being installed as Pull to Open or Push to Open?

Pull to Open **Default Setting**

Gate opens inwards towards the property

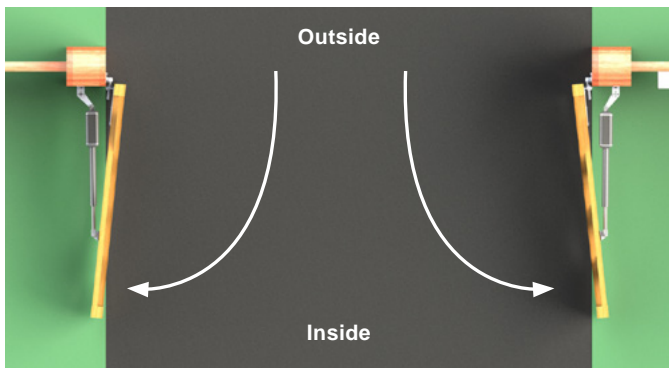

Refer to page 11 for pull to open instructions

Push to Open **Optional Setting**

Gate opens outwards from the property

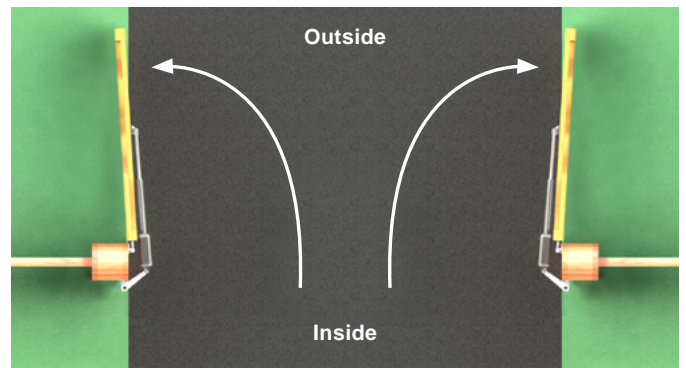

Refer to page 27 for push to open instructions

Please note: your gate must never open into public spaces

**Please Note: This gate kit is FACTORY set to be a PULL to OPEN.
If you require a PUSH to OPEN setting please refer to Page 27 for PUSH to OPEN instructions**

Tools Required for Installation:

- Power Drill & Drill Set
- Tape Measure
- Open End Wrenches – #14 & #17 or Adjustable Wrenches
- C-Clamps: Small, medium, and large
- Level
- Hacksaw or Heavy Duty Bolt Cutters
- Phillips Head Screwdriver
- ø40mm or ø20mm Electrical Conduit (enough to cover the width of your gate opening)
If using ø20mm conduit the motor plug for gate motor 2 will need to be cut and wired back into the control box. Refer to the control board wiring diagram on page 25 (for pull to open) or page 27 (for push to open)

We recommend getting an extra person to help with installation if possible

Gate Preparation:

Check that the swing gate is correctly installed and level, and that the gate hinges/bearings are greased and in good condition. Any misalignment or binding in the setup of the gate may cause problems with the gate opener or difficulties opening the gate.

This gate arm is to suit Pull-to-Open installation, in which the gate opens into the property. The gate arm can also be used for Push-to-Open installation, see Page 27 of this manual for more details.

Ensure that the gate does not open into public areas.

The gate opener connects to the gate and to the gate post. The Post Brackets can be fitted to a round or square post. When mounting the Post Brackets, use bolts long enough to pass through the entire post. M10 x 200mm bolts are included. **Concrete anchors are not provided.**

When mounting the Post Brackets to wooden posts, a larger-size washer or metal plate should be used between the bolts and the wooden post to ensure the stability of the fastening hardware. **If the post is smaller than 6" diameter or square, it should be made of metal and set in cement.**

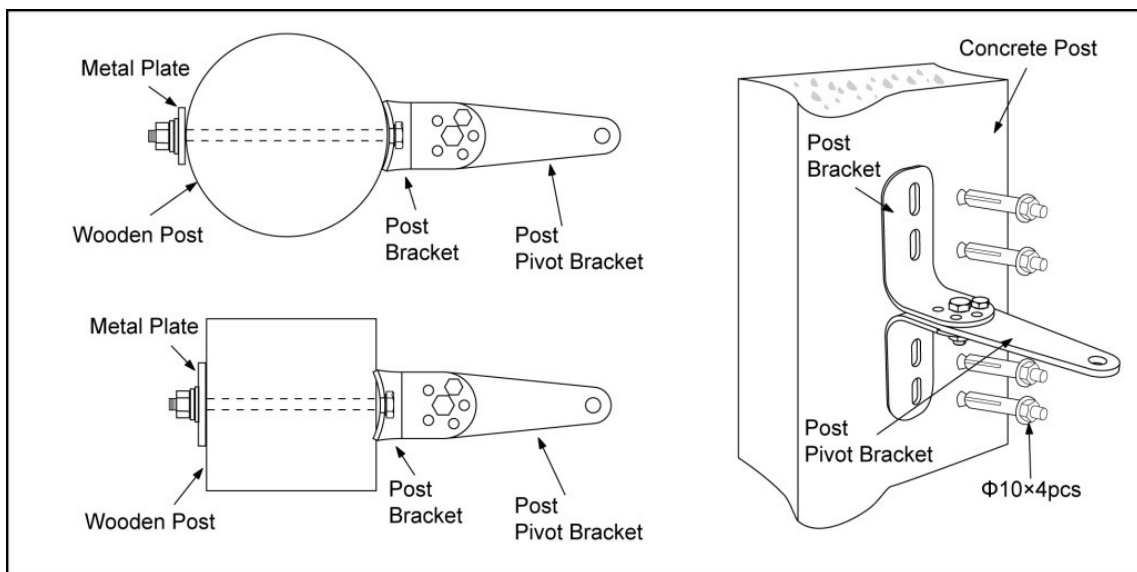

Fig 1

Before starting we recommend watching the installation video that can be found at:

richmondau.com/product/gtr058-double-swing-gate-opener/

This video will give a detailed overview of the installation process and will serve as a useful aid during installation.

Step 01: Assembling the Post & Pivot Bracket:

1. Insert the M10 x 30 bolt through the center hole of the post bracket and post pivot bracket as shown in Figure 5. Place a $\phi 10$ washer, $\phi 10$ spring washer and M10 nut on the bottom of the bolt and hand tighten so that the pivot plate can swivel side to side.



Lay out the parts ready to assemble



Post pivot bracket in between the two post brackets

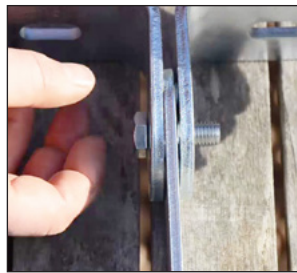

Insert the M10 x 30 bolt through the hole in the post pivot bracket

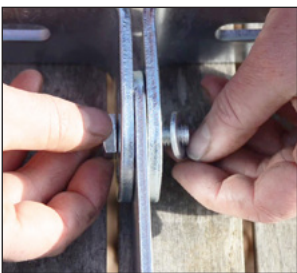

Add the $\phi 10$ washer

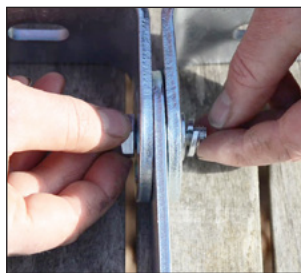

Add the $\phi 10$ lock washer

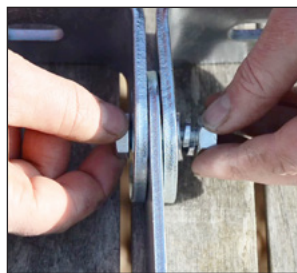

Secure in place with the M10 nut

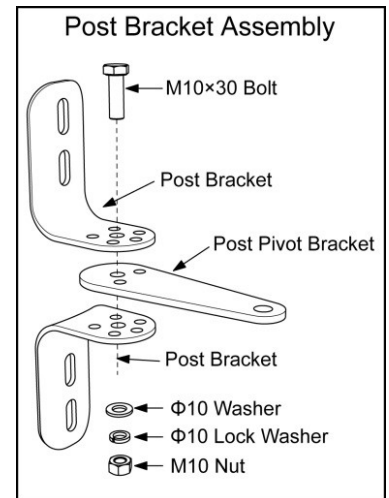
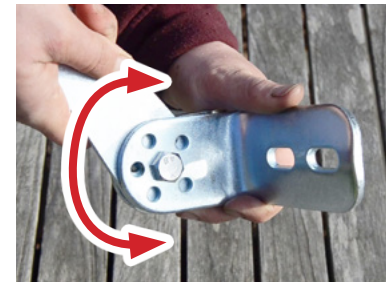

Fig 2



PLEASE NOTE:
Make sure that the assembled post pivot bracket can swivel freely by hand.

2. Attach the Gate Bracket Assembly and Post Bracket Assembly to the opener by inserting the clevis pin. Temporarily secure the clevis pins using the hairpin clips as shown in Figure 3

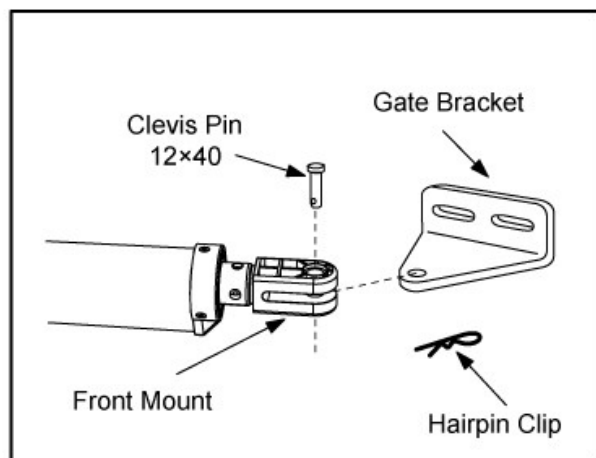
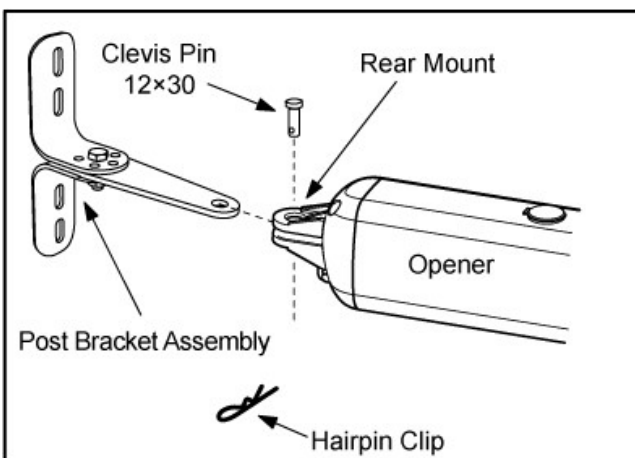

Fig 3

Gate Arm Mounting:

The position of Post Bracket is very important. The following illustrations and tables are required to determine the proper mounting position for the Post Bracket, with the gate in the closed position. The table in Figure 5 shows the maximum opening angle of the gate for a given A and B. For example, if A is 15cm and B is 20cm, the maximum opening angle of the gate is 110°.

Figure 4 below shows simple pivot bracket positioning to achieve a minimum of 95° range of motion.

Note: Installing GTR058 on a Dual gate, steps 1-9 will apply to Gate Opener 1 (with 1.5m of cable), which should be mounted on the control box side of the property. You will need to repeat these steps for Gate Opener 2 (with 6m of cable).

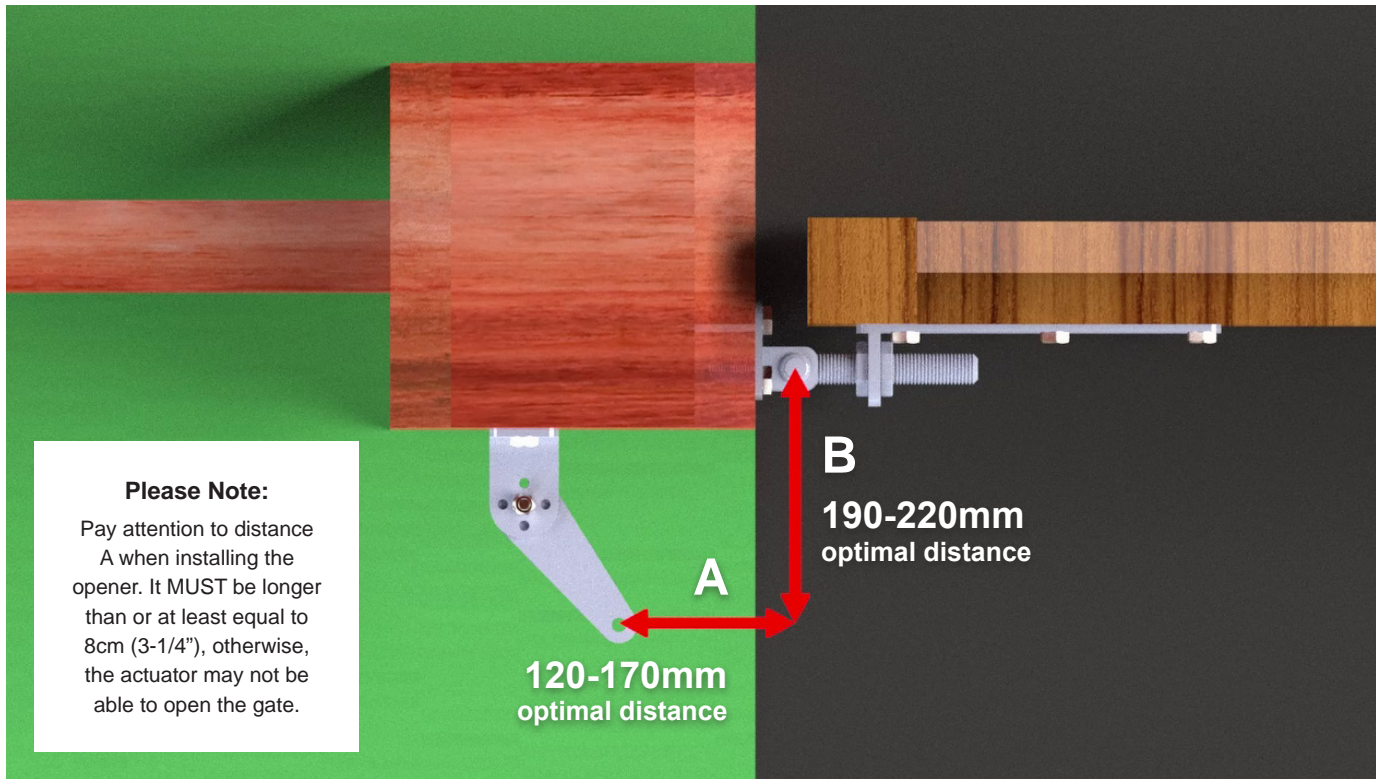

Fig 4

To find the maximum opening range of motion based on the set distances of **A** and **B**, refer to the table below:

	A=8cm	A=9cm	A=10cm	A=11cm	A=12cm	A=13cm	A=14cm	A=15cm	A=16cm	A=17cm	A=18cm	A=19cm	A=20cm
B=19cm	90°	93°	96°	98°	101°	104°	106°	108°	110°	105°	102°	98°	95°
B=20cm	91°	93°	95°	98°	100°	103°	107°	110°	104°	99°	96°	94°	92°
B=21cm	91°	93°	95°	97°	100°	103°	106°	103°	99°	96°	93°	91°	
B=22cm	91°	94°	95°	97°	99°	101°	103°	98°	95°	92°	90°		
B=23cm	92°	94°	96°	98°	100°	103°	98°	94°	92°	90°			
B=24cm	90°	92°	95°	97°	99°	97°	93°	91°					
B=25cm	90°	92°	94°	97°	96°	92°	90°						
B=26cm	90°	92°	94°	95°	91°								
B=27cm	90°	92°	95°	90°									

Fig 5

Step 02: Set the Motor to Manual Mode:

Remove the release plug on the top of the gate arm, insert the release key, and turn the key 90° clockwise. This puts the gate arm into manual mode, allowing the gate arm to be manually extended and retracted. To restore normal operation, turn the key 90° anti-clockwise.

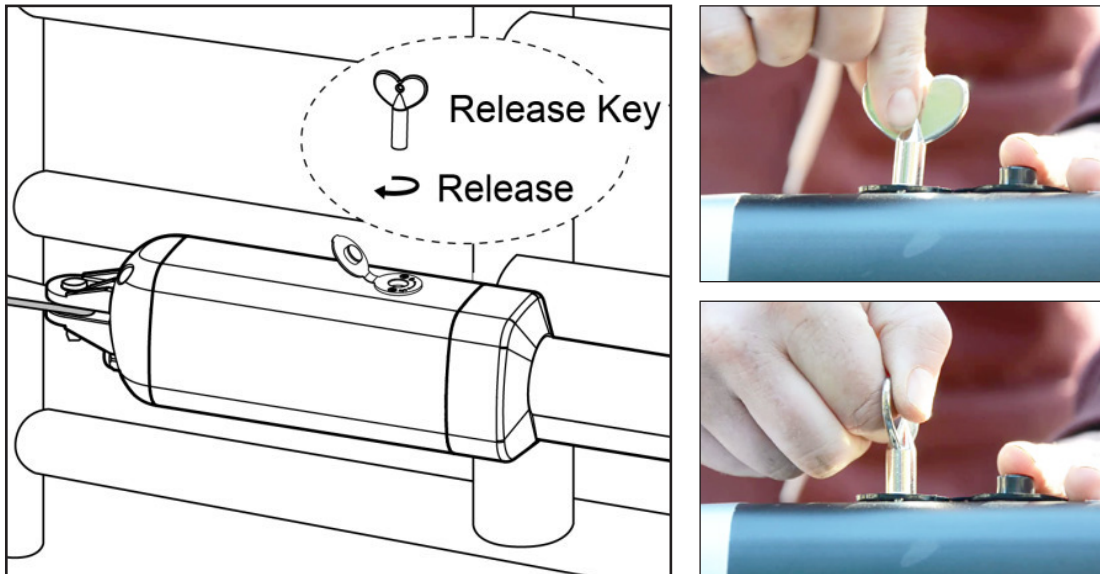

Fig 6

Step 03: Positioning the Gate Bracket & Opener:

With the gate arm fully retracted and the gate in the fully open position, place the gate arm with the Post Bracket Assembly on the gate post and Gate Bracket on the gate. Position the Post Bracket Assembly and Gate Bracket so that the gate arm is level. While holding the gate arm level, temporarily secure it with two C-clamps.

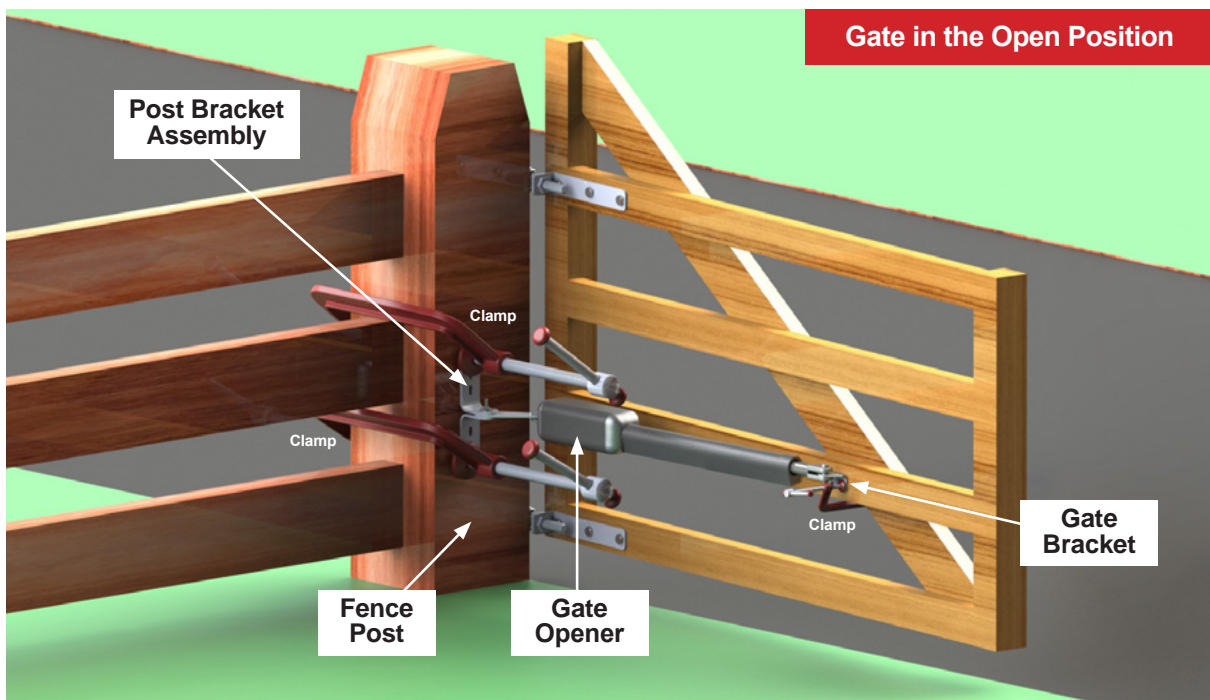

Fig 7

with the gate motor attached with clamps (while the gate motor is unlocked in manual mode) ensure your gates range of motion is past your ideal closed position & can fully open.

If you cannot achieve your desired range of motion with the gate in manual mode refer back to the table on page 12 (Fig 5) and make any adjustments to the pivot bracket and gate bracket required to achieve full range of motion.

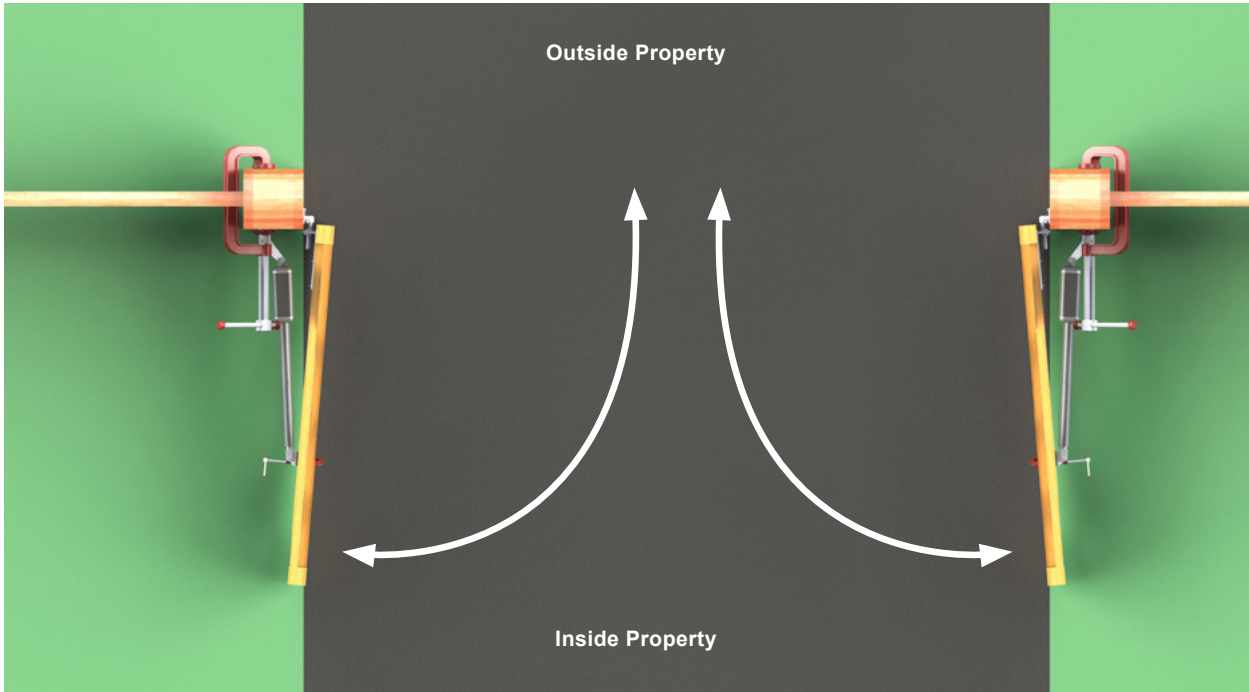
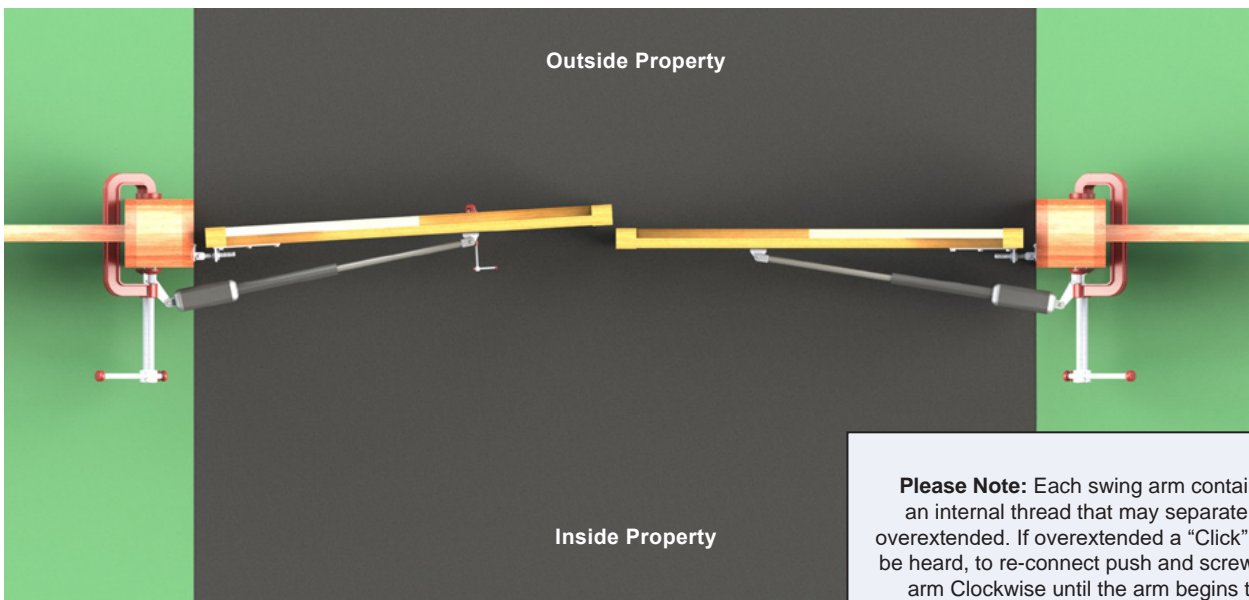

Fig 8



Please Note: Each swing arm contains an internal thread that may separate if overextended. If overextended a "Click" may be heard, to re-connect push and screw the arm Clockwise until the arm begins to retract by hand.

Fig 9

Do not proceed any further until you can achieve your full range of motion with everything positioned using clamps!

Step 04: Setting the Minimum Clearances:

Make sure that there is a minimum clearance of 2.5cm between the gate and the gate opener, to prevent the gate opener touching the gate while opening.

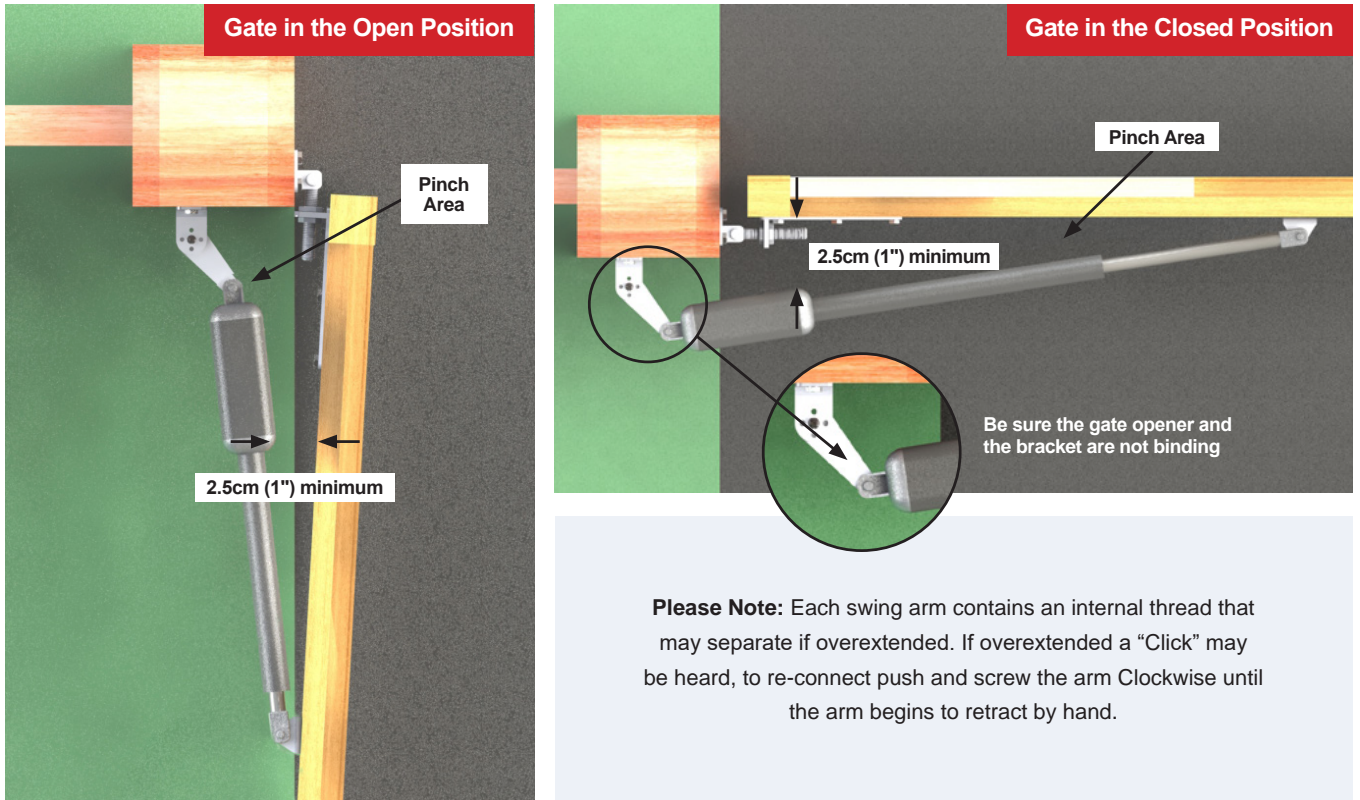
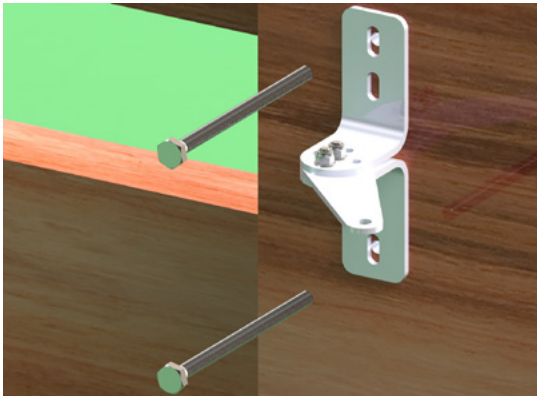

Fig 10

Step 05: Affixing the Post & Gate Brackets:

Mark the bolt-hole points on the gate post and the gate. We recommend marking the middle of each bolt slot on the Post Brackets and the Gate Bracket, this will allow slight adjustments in positioning. Once the holes are marked, remove the post bracket and gate bracket by taking off the C-clamps.



Mark the fence posts through the middle of the bracket slots and drill $\varnothing 10.5\text{mm}$ holes.

Fig 11

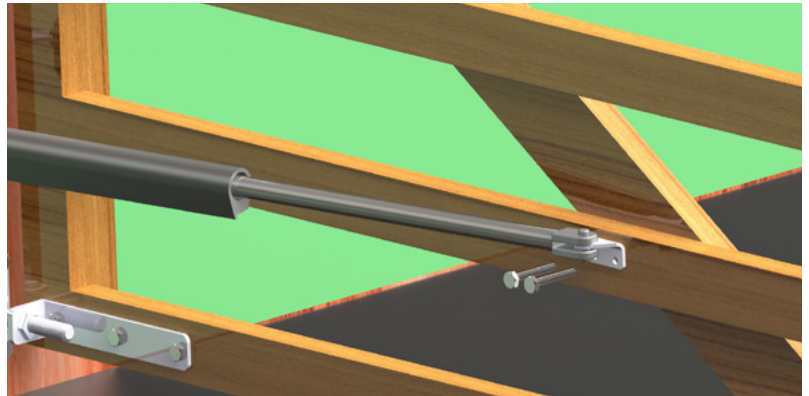

Through the center of each of the gate bracket slots, mark the cross member. Drill $\varnothing 10.5\text{mm}$ holes in the marked position.

Fig 12

- Drill $\varnothing 10.5\text{ mm}$ diameter holes through the post and the gate at the marked locations.
- Secure the post bracket assemblies to the gate posts using the M10 x 200mm bolts, nuts and washers supplied.
- Secure the gate brackets to each gate using the M10 x 75mm bolts nuts and washers supplied.
- You can cut off any part of the bolts that extend beyond the tightened nuts.
- With the gate opener fully retracted and the gate in the fully opened position, reattach the gate opener to both brackets, using the pins and hairclip pins to secure.
- Check again that the gate swings smoothly by hand, and that the gate arm is level.
- Open the release plug on the top of the gate arm, insert the release key, and turn the key 90° anti-clockwise. This puts the opener back into automatic mode.

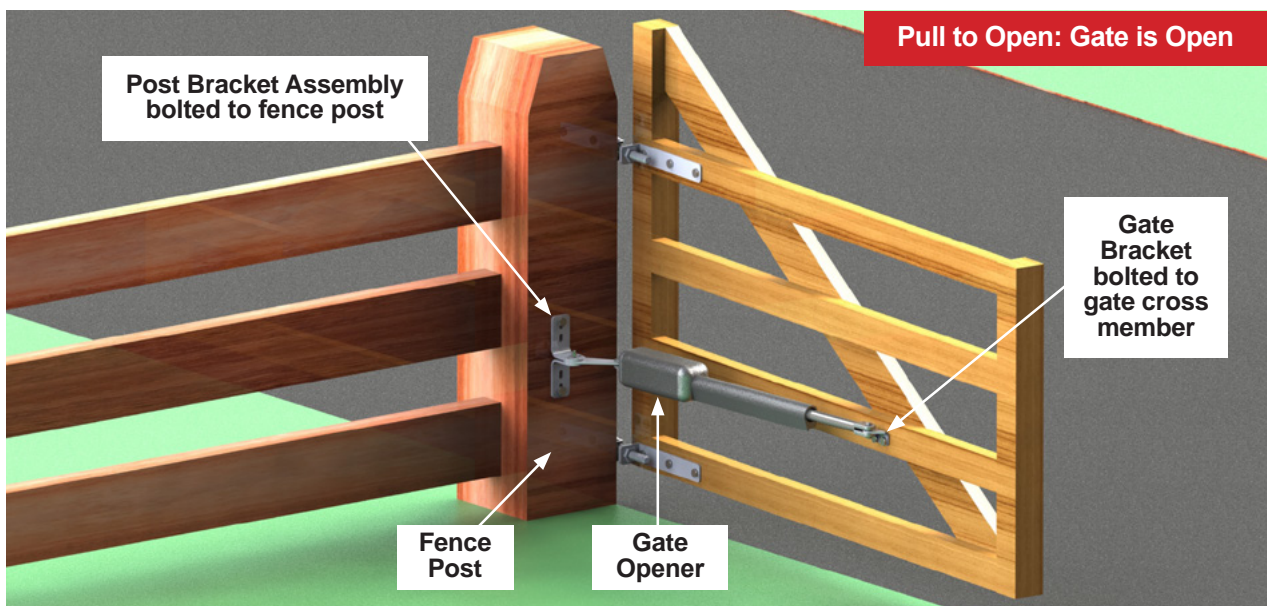

Fig 13

Step 06: Mounting the Control Box:

The control box comes with an Australian Standard power cord wired in.

Remove the cover of the control box, use 4 screws or bolts (not provided) to mount to a secure surface. The plugs must be facing downwards, and at least 100cm above the ground.

All wiring at high voltage (240VAC/50Hz) must be completed by a qualified electrician.

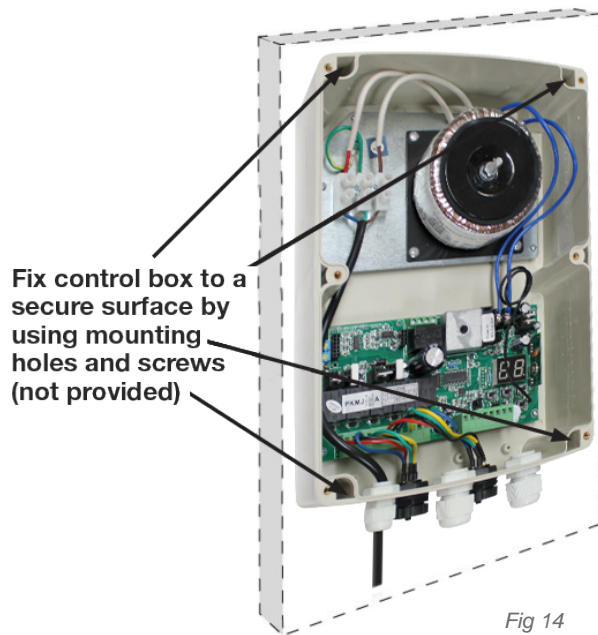

Step 07: Running the Motor Cable

The GTR058 requires a power line for gate motor arm 2 to be run underground for connection to the control box. For safety the 6m cable needs to be run through conduit under your driveway.

- Dig a trench approximately 150mm deep between your two gate posts.
- Using $\varnothing 40\text{mm}$ or $\varnothing 20\text{mm}$ conduit, run the cable for motor 2 through the trench, using 90° conduit fittings to bring the cable up where it meets the gate motor and control box at each end.
If using $\varnothing 20\text{mm}$ conduit the motor plug for gate motor 2 will need to be cut and wired back into the control box. Refer to the control board wiring diagram on page 25 (for pull to open) or page 27 (for push to open)
- Connect the cable for Motor 2 to the control box.
- Fill in the trench to secure the electrical conduit in place.

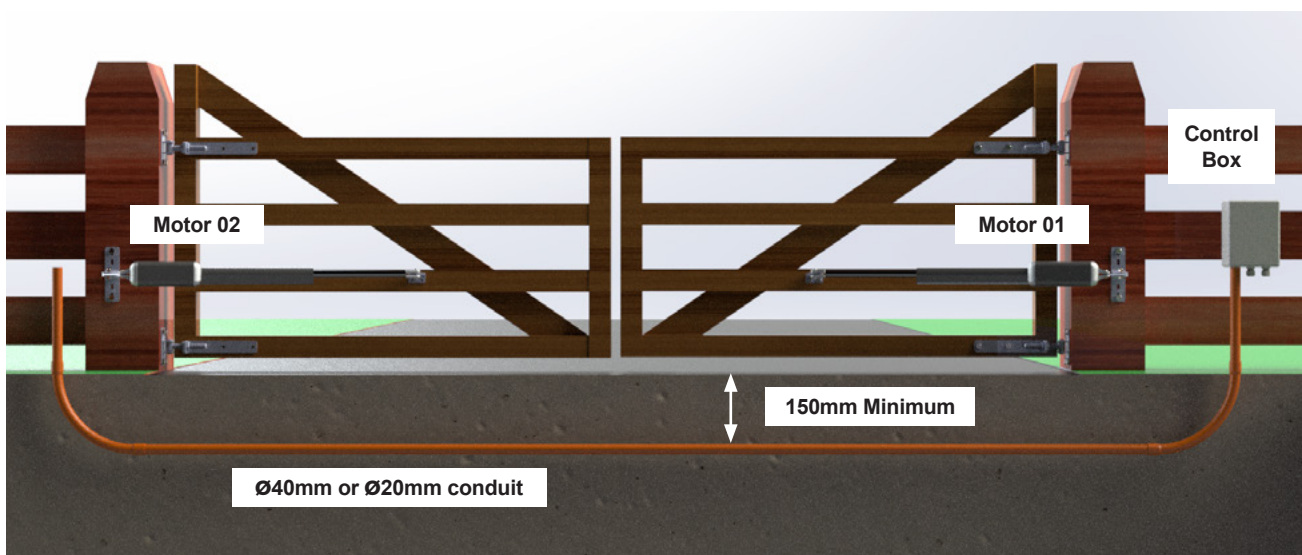

Fig 15

Step 08: Connecting the Gate Arm:

- Ensure that the control box is installed on the side of Gate Motor 1.
- Connect the Motor Plug on the Gate Arm to the socket on the control box labelled Motor 1 and tighten the sealing nut.
- Connect the Motor Plug on the second Gate opener to the socket labelled Motor 2 and tighten the sealing nut.

Note: It is recommended that Gate Motor 1 is installed as the Primary gate opener, and Gate Motor 2 is installed as the Secondary gate opener.



Fig 16

Motor Plug	
	Socket
	Plug
Strain Relief	
	Lock Nut
	Hub
	Sealing Nut

Fig 17

Optional accessories can be wired into the control box by feeding the cable through the extra cable glands fitted to the control box. Feed the cable through a gland, ensure enough cable length to wire the cable to the circuit board and retighten the gland to secure the cable.

Refer to Figure 20 for details on how to connect optional accessories to the control board.

Step 09: Adjusting the Travel Limit Switch:

The limit switch controls the closed position (stop point) of the gate. Moving the limit switch closer to the hinge point of the gate (the gate post) will make the gate stop at an earlier point when closing. Moving the limit switch away from the hinge point will make the gate stop at a later point when closing.

To adjust the limit switch, use a screwdriver to loosen the screw of Limit Switch **A**, slide to the correct position, and then tighten the screw again (refer to fig 18)

Please Note: The adjustable limit switch on each gate opener may need to be set at slightly different positions to achieve the perfect close position for each gate.

Pull to Open Limit Switch Adjustment:

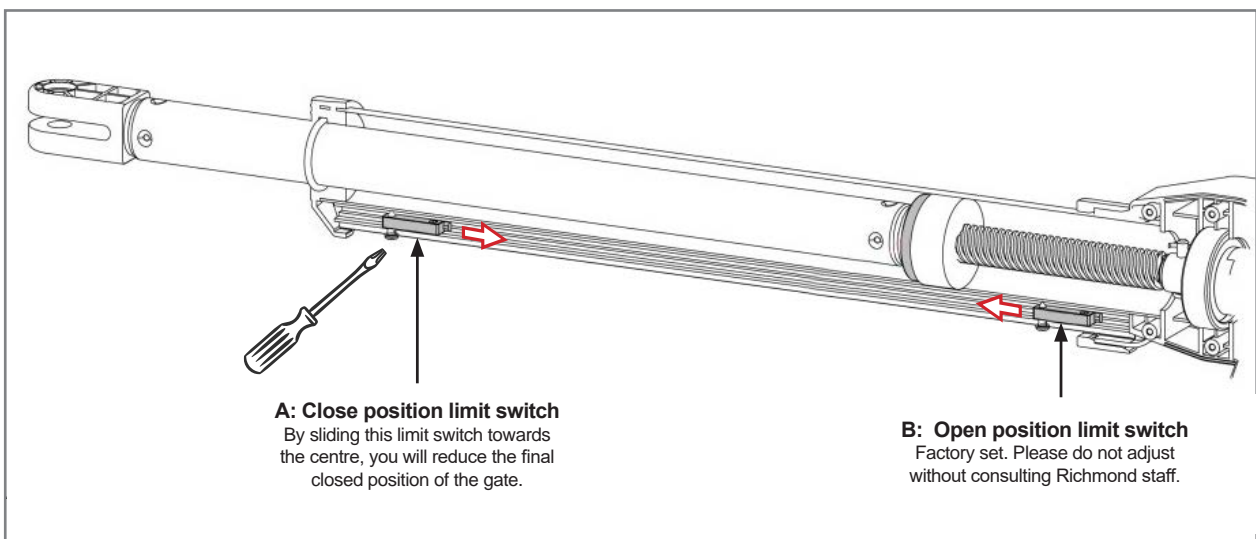
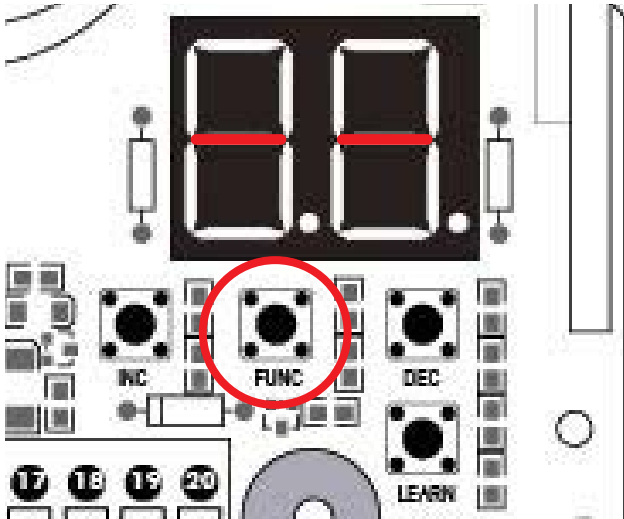

Fig 18

Please Note: Each swing arm contains an internal thread that may separate if over extended. If overextended "Click" may be heard, to re-connect push and screw the sliding arm Clockwise until the arm begins to retract by hand.

Programming the Gate Opener:

The following steps detail how to adjust the operation of your swing gate motor, to accommodate individual operational requirements. While the control box power is turned on, the digital display on the circuit board will flash "-- --". This means the unit is in operation mode (ready to open and close your gate).



To enter programming mode and change any program settings press and hold the FUNC (function button for 4 seconds. The digital display will flash P1 (Program 1) Meaning you can adjust Program 1 settings.

- To change settings to any of the programs press the **INC** (Increase) or **DEC** (Decrease) buttons, to change the setting option. Pressing the FUNC button will save the new setting highlighted and cycle to the next program option.
- To exit programming mode and return to operating mode press the FUNC button repeatedly until the "-- --" symbols displayed.

P1: Dual Gate or Single Gate Setting.

11 - Dual Gate Mode (2 swing gate motors fitted)

01 - Single Gate Mode (Single swing gate motor fitted to motor 1 plug)

10 - Single Gate Mode (single swing gate motor fitted to motor 2 plug)

Dual Gate Arm Mode Default setting is '11' (Dual gate mode).

P2: Primary/Secondary Motor Selection Setting.

The Primary Gate is the gate you want to open and close first.

Where possible the motor marked as 'Motor 1' is recommended to be the primary gate.

01 – Motor 1 is the Primary, Motor 2 is the Secondary

10 – Motor 2 is the Primary, Motor 1 is the Secondary

Default setting is '01'.

P3: Primary/Secondary Motor Opening Interval Setting.

Adjusting this value will change the time interval between the Primary Gate opening and the Secondary Gate opening. By default, the Primary gate will begin opening 3 seconds before the secondary gate. If you would like both your gates to open simultaneously adjust this setting to 0 (seconds).

Default setting is '3'.

This value can be set between 0-9 seconds. Setting the value to '0' means both gates will open simultaneously, while setting the value to '9' means that the Secondary Gate starts to open 9 seconds after the Primary Gate.

Note: If you are fitting an electric lock to your swing gate. Please keep P3 set to 3 seconds or longer.

P4: Primary/Secondary Closing Interval Setting.

Adjusting this value will change the time interval between the Primary Gate closing and the Secondary Gate closing. By default, the Primary gate will begin closing 3 second before the secondary gate. If you would like both your gates to begin closing simultaneously adjust this setting to 0 (seconds).

Default setting is '3'.

This value can be set between 0-9 seconds. Setting the value to '0' means both gates will open simultaneously, while setting the value to '9' means that the Secondary Gate starts to open 9 seconds after the Primary Gate.

Note: If you are fitting an electric lock to your swing gate. Please keep both P4 set to 3 seconds or longer.

P5: Stall Force of Gate Motor 1

The Stall Force setting adjusts the amount of resistance required to stop the motor. The value can be set between 0-9. '1' means minimum force detected will stop the gate, '9' means the maximum force detected is required to stop the gate. If an impact is detected during the opening cycle, the gate will stop. If an impact is detected during the closing cycle the gate will stop, and then re-open.

For safety, this setting should be high enough that small objects such as branches or wind will not cause interruptions, but low enough to detect collisions with a person or vehicle.

Default setting is '3'.

***NOTE* The Stall Force is an important part of the safety features. After any adjustments are made, this function must be re-tested. Never increase the Stall Force to compensate for a gate that is dragging on the ground, or that is too difficult to move manually (without motor force).**

P6: Stall Force of Gate Motor 2.

As per above description for P5, the value can be set between 0-9. '1' means minimum force detected will stop the gate, '9' means maximum force.

Default setting is '3'.

P7: Max Running Time of Gate Motor 1.

The Max Running Time can be set to stop the motor running after a set period of time. The value can be set between 1 – 50 seconds. This is the maximum length of time the motor will try and open or close for.

The value can be set between 1 – 50 seconds. '1' means the Gate Arm 1 will stop after 1 second.

Default setting is '40' (seconds). There is no need to adjust this setting.

P8: Max Running Time of Gate Motor 2.

As per above description for P7

The value can be set between 1 – 50 seconds. '1' means the Gate Arm 1 will stop after 1 second.

Default setting is '40' (seconds). There is no need to adjust this setting.

P9: Enable Infrared Photocell Setting.

Enable this setting when Infrared Photocells are being used.

00 – Infrared Photocell disabled.

11 – Infrared Photocell enabled.

Default setting is '00'. (infrared photocell disabled)

Note: if you have fitted an infrared photocell for safety such as our GTR208 adjust this setting to "11" (infrared photocell enabled) to use this safety feature.

PA: Auto Close Setting.

This setting allows you to enable and/or adjust the amount of time a gate stays open before automatically closing. The value can be set between 1 – 99 seconds. '00' means that the Auto Close feature is disabled and the gate will stay open until the remote button is pressed again. '1' means the gate will start to close 1 second after it has finished opening.

Default setting is '60' seconds / Gate will automatically close after 60 seconds.

Note: We recommend when using the Auto Close Function that you fit an Infrared safety Photocell such as our GTR208 to reduce the risk your gate may accidentally close on a vehicle or pedestrian.

Pb: Soft Start Setting.

The Soft Start feature means that the gate will start to open slowly for a set period of time, then open at the regular speed. This can prevent wear and tear on the Gate Opener and the gate itself.

The value can be set between 1 – 9 seconds. '1' means that the Gate Arm will open slowly for 1 second then proceed at the regular speed.

Default setting is '3'.

PC: Soft Stop Setting.

As above, the Soft Stop feature means the gate will slow down slightly before reaching the final closed position.

Default setting is '15'.

Note: lowering this program number increases the amount of time the gate will move slowly while closing, increasing this program number will decrease the total amount of time the gate requires to close.

Pd: Reset to Default Settings

While on the **Pd** setting, press and hold the '**INC**' or '**DEC**' button, and the digital display will show '**dF**'. All settings will be restored to the default settings.

The digital display will show the status of both Gate Arms during operation. The first symbol refers to Motor 1, and the second symbol refers to Motor 2. During opening, the symbol will display 'n', and during closing the symbol will display 'u'.

Pd: Reset to Default Settings

While on the **Pd** setting, press and hold the **INC** or **DEC** button, and the digital display will show **dF**. All settings will be restored to the default settings.

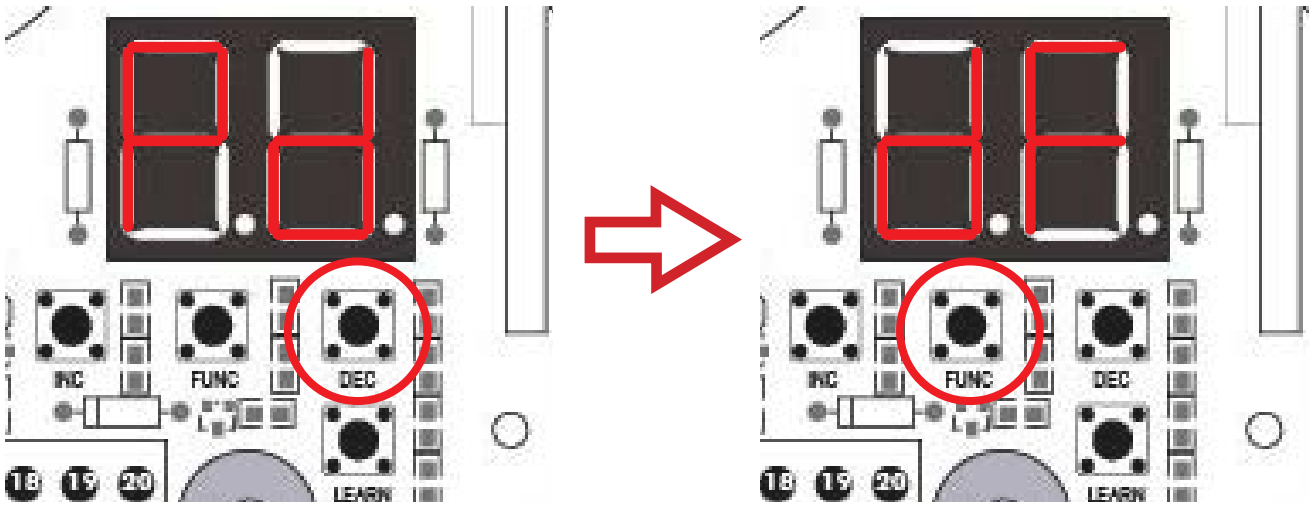

To reset all settings to factory default while the digital display shows 'Pd' Press and hold the DEC button.

When the digital display shows 'dF' you have successfully returned all settings to factory default settings. Press the FUNC button until the "-- --" symbol is displayed to return to operating mode.

Please Note: The digital display will show the status of both Gate Arms during operation. The first symbol refers to Motor 1, and the second symbol refers to Motor 2. During opening, the symbol will display 'n', and during closing the symbol will display 'u'.

Please Note: The two remotes that come with this kit are already paired and ready for use. If the remotes need to be paired again, or you wish to pair additional remotes, please follow the steps below.

Pairing Additional Remote Controls

While the power is on, and the control box cover is removed, press the button 'LEARN' on the control board, until the LED turns on, then release the button. While the light is on, press the first button on the remote control twice, the LED will flash repeatedly and then turn off when remote control is paired. Up to 10 remote controls can be paired. Refer to Figure 18.

Clearing Remote Controls

To delete all paired remote controls, press and hold the button 'LEARN' for approx. 8 seconds. When the 'LEARN' LED turns off, all previously paired remote controls that will be deleted. (refer to fig 19)

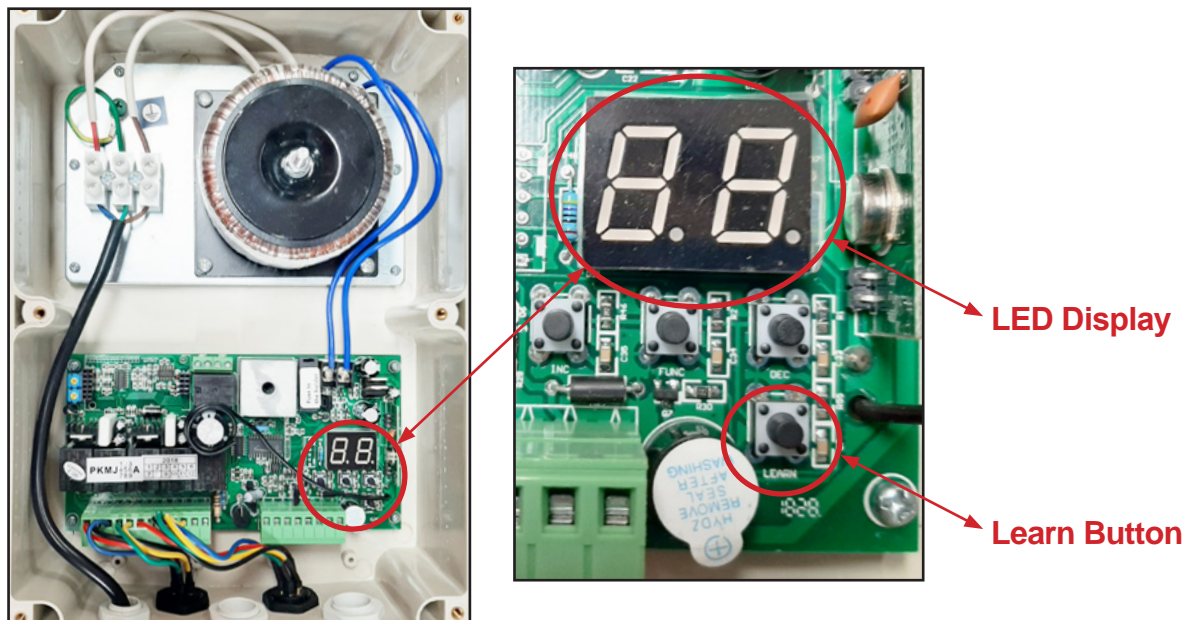

Fig 19

Additional remotes can be purchased separately. **Part number: GTR054**

Programming and Wiring:

Control Board Wiring Diagram:

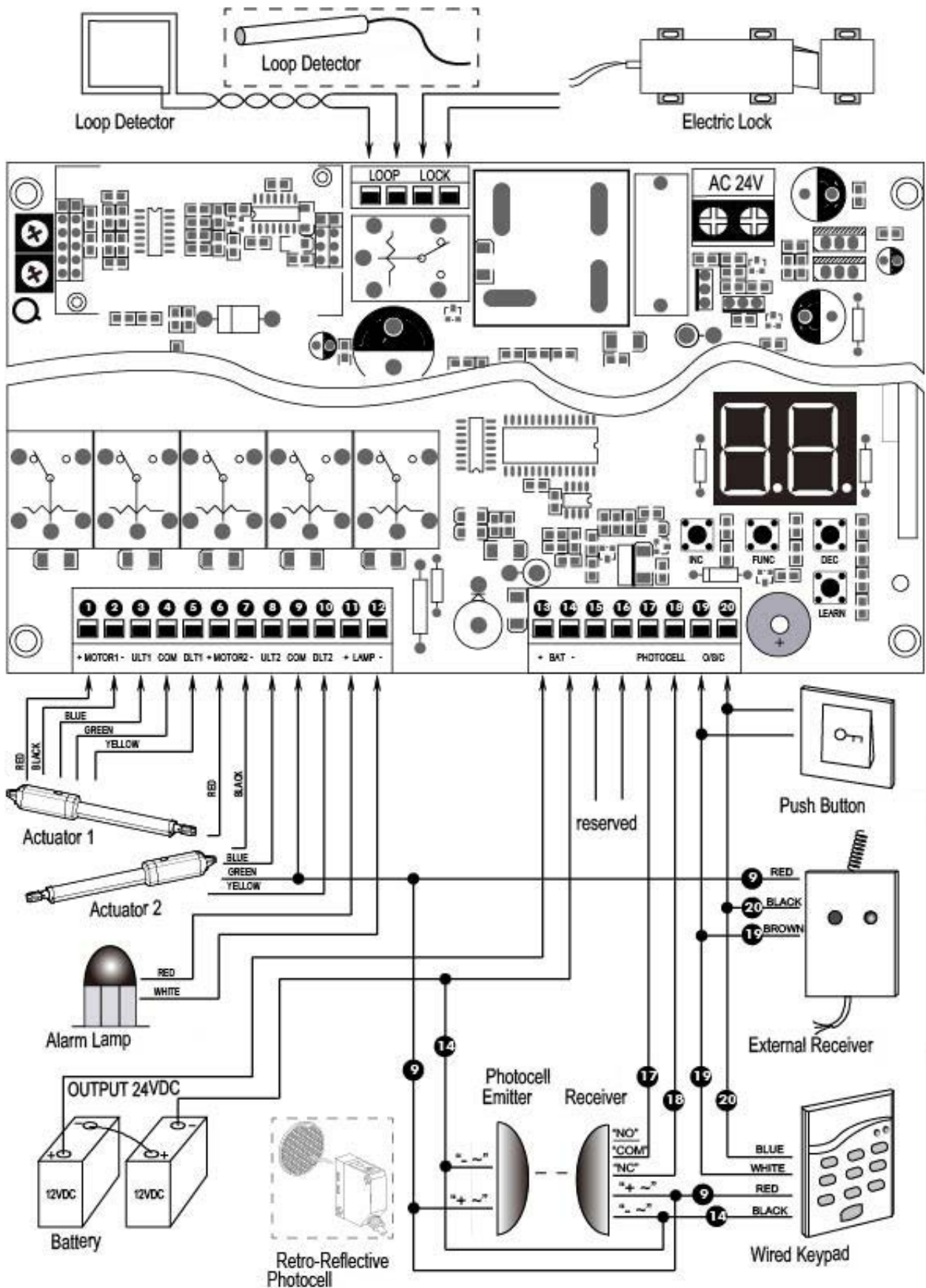

Fig 20

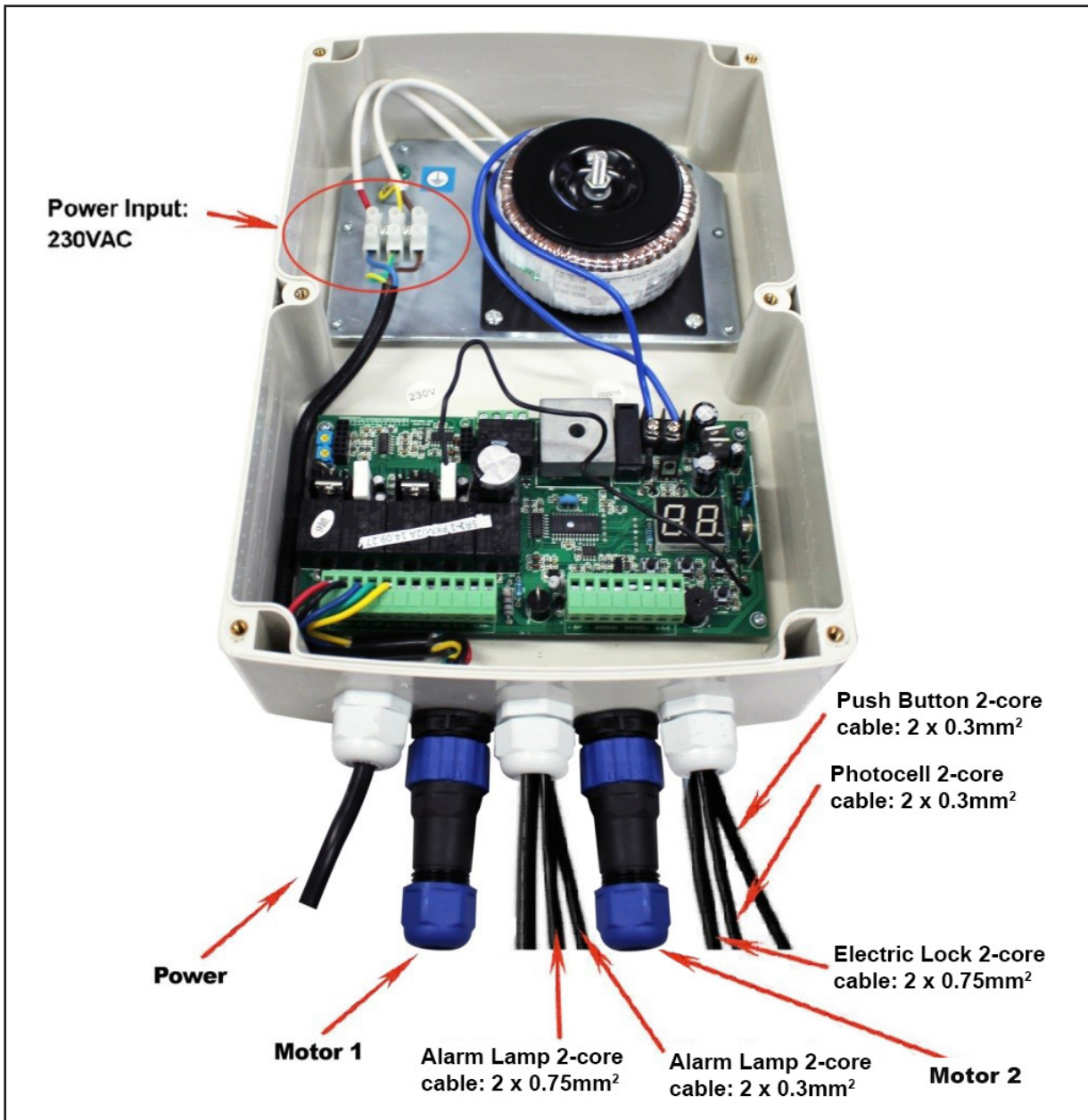

Fig 21

Maintenance:

- Under normal operation, the gate should be checked every 6 months:
- Lubricate gate hinges
- Check and tighten all fixture bolts
- Check for loose and corroded wires.
- Always check the stall force after performing any maintenance. If this function does not work, do not use the gate motor until this is rectified.
- Use the key to put the gate arms in manual mode and check opening/closing sequence by hand.
- Discretion should be used to check more often, and after heavy wind and storms.

Optional Installation: Operating the Gate as Push to Open:

The GTR058 can be used as a Push-To-Open gate, you will need to use an Optional Push-To-Open Bracket (GTR059, sold separately) or mount the Post Bracket Assembly to the nearest side of the gate post opening. Note that in this configuration, the gate arm is retracted in the Closed position, and extended in the Open position. Refer to Figures 22 and 24 for details on how to mount.

To enable Push-To-Open, you will need to change the wires from each actuator(arm) so that the wire colours match the diagram in Figure 23 below.



GTR059 bracket required for push to open installation (sold separately)

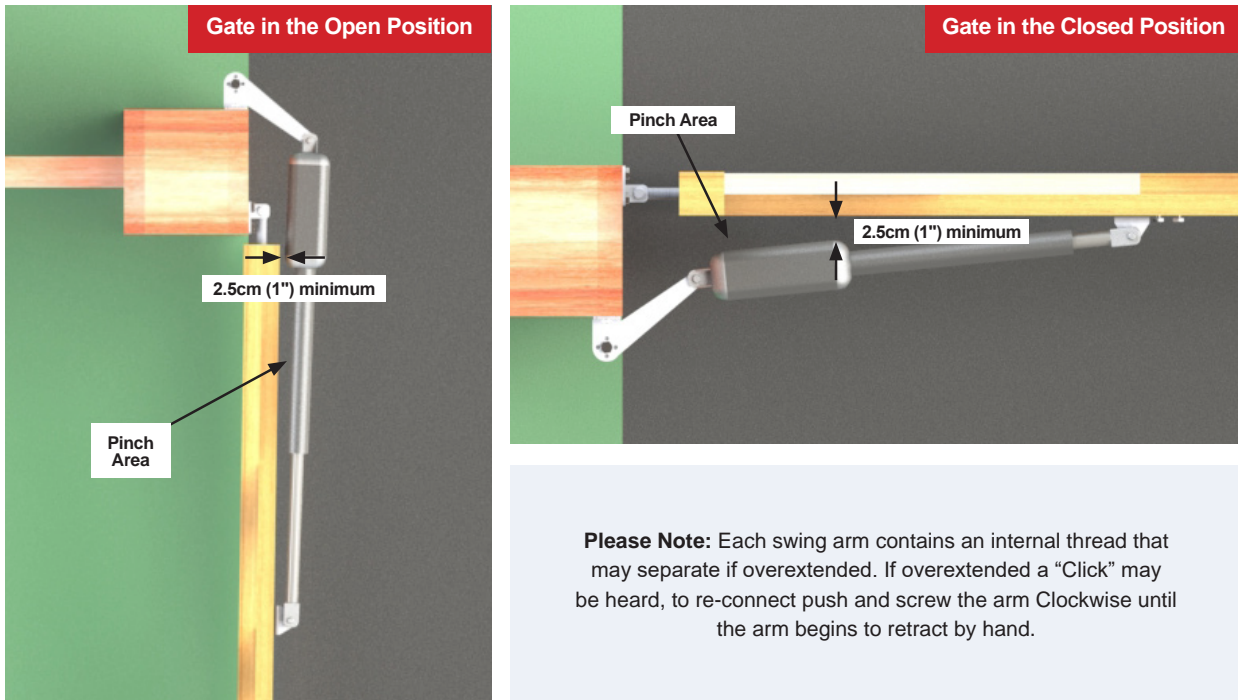
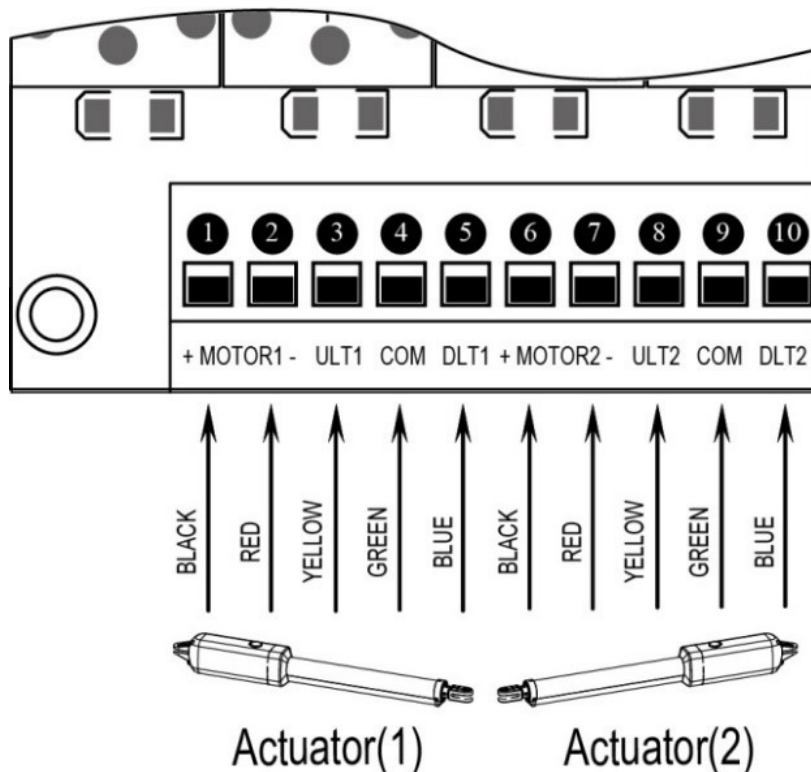

Fig 22

Wiring for Push to Open Installation:



Please Note: To operate the gate as push to open the wires inside the control box for each motor need to be changed to match this diagram (right)

Fig 23

Push to Open Clearances:

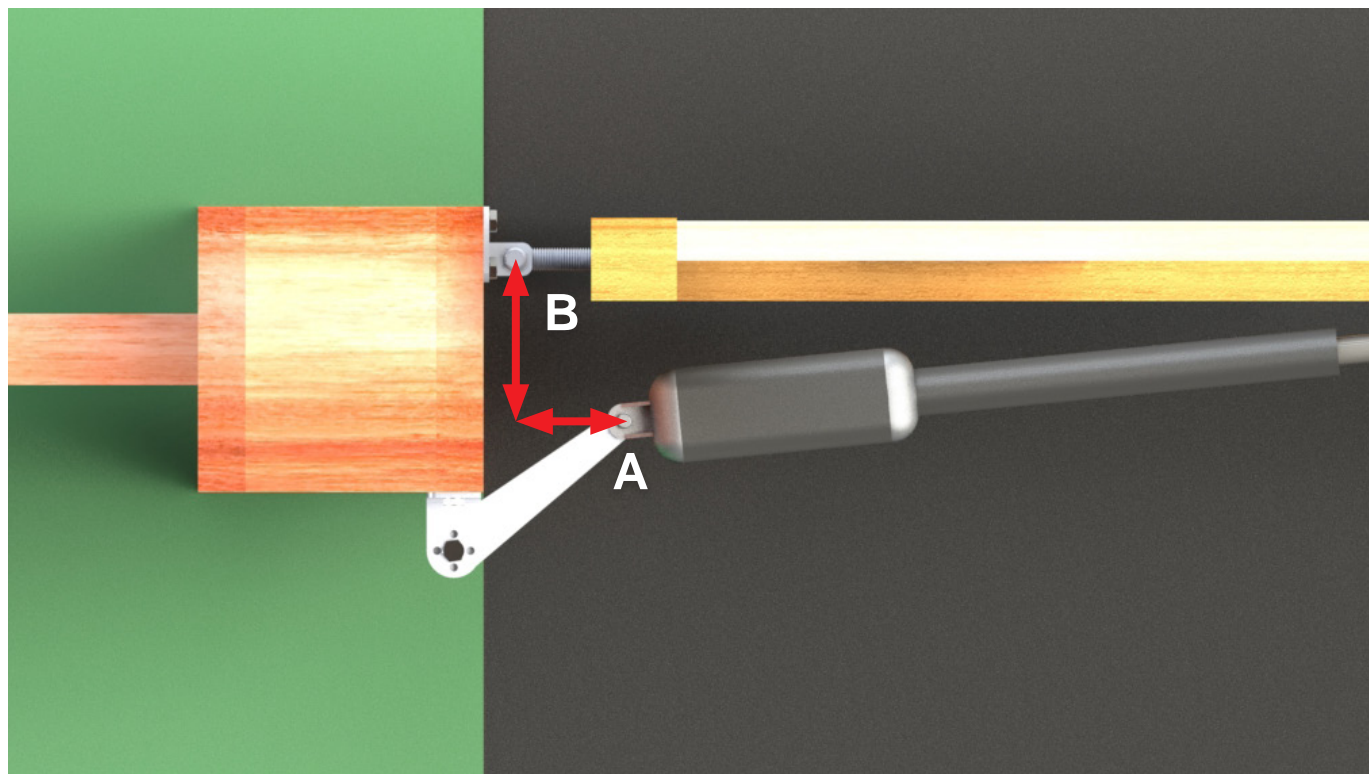

Fig 24

To find the maximum opening range of motion based on the set distances of **A** and **B**, refer to the table below:

	A=10cm	A=12cm	A=14cm	A=16cm	A=18cm	A=20cm	A=22cm	A=24cm	A=26cm
B=9cm	90°	100°	111°	120°	125°	117°	108°	99°	90°
B=11cm	90°	98°	107°	115°	120°	111°	100°	92°	86°
B=13cm	90°	97°	104°	110°	114°	104°	94°	87°	
B=15cm	90°	98°	105°	112°	109°	97°	89°		
B=17cm	90°	96°	101°	108°	101°	91°	83°		
B=19cm	90°	95°	100°	106°	93°	85°			
B=21cm	90°	94°	99°	97°	87°				
B=23cm	90°	93°	97°	90°	81°				
B=25cm	90°	93°	94°	83°					
B=27cm	90°	92°	86°						

Fig 25

Please Note: If the gate goes past your required closed position at full extension. This can be adjusted with the motor's limit switches. Refer to Pg 30 for instructions on adjusting this setting for a push to open installation.

Positioning the Gate Bracket & Opener for Push to Open Installation:

With the gate arm fully retracted and the gate in the fully open position, place the gate arm with the Post Bracket Assembly on the gate post and Gate Bracket on the gate. Position the Post Bracket Assembly and Gate Bracket so that the gate arm is level. While holding the gate arm level, temporarily secure it with two C-clamps.

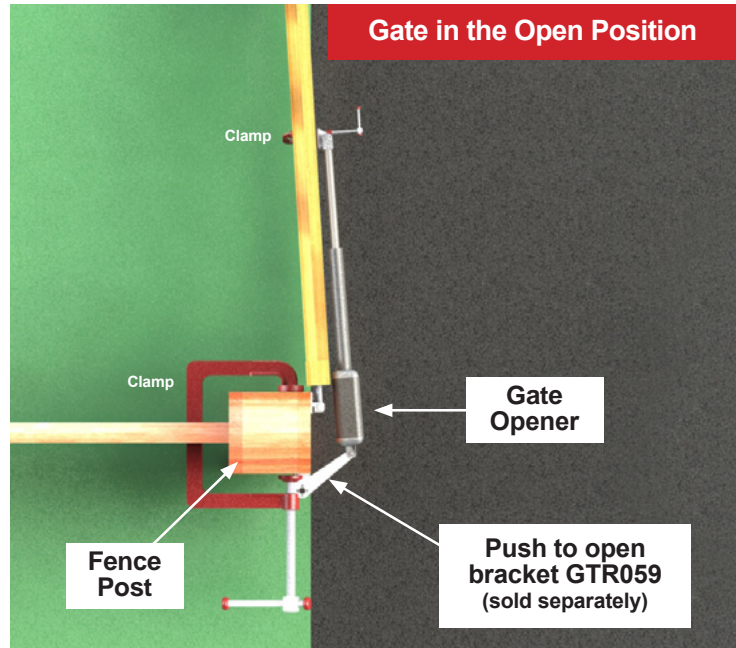

Fig 26

With the gate motor attached with clamps (while the gate motor is unlocked in manual mode) ensure your gates range of motion is past your ideal closed position & can fully open.

If you cannot achieve your desired range of motion with the gate in manual mode refer back to the table on page 28 (Fig 26) and make any adjustments to the pivot bracket and gate bracket required to achieve full range of motion.

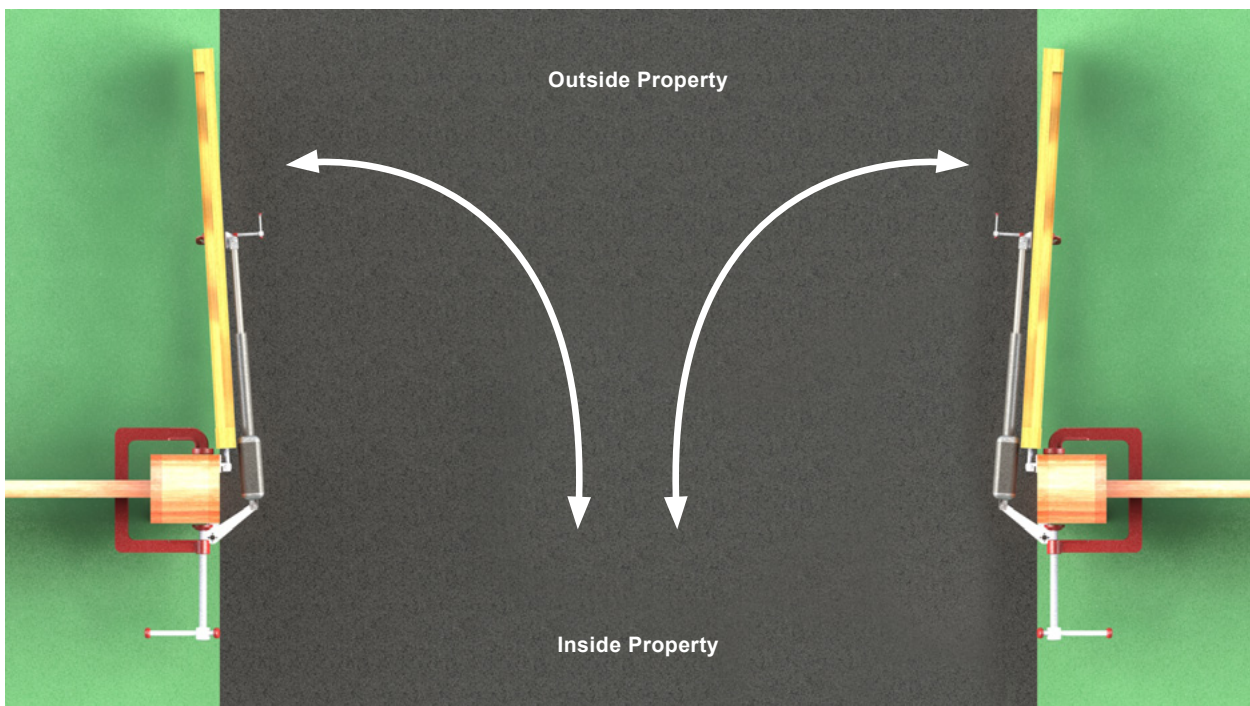

Fig 27

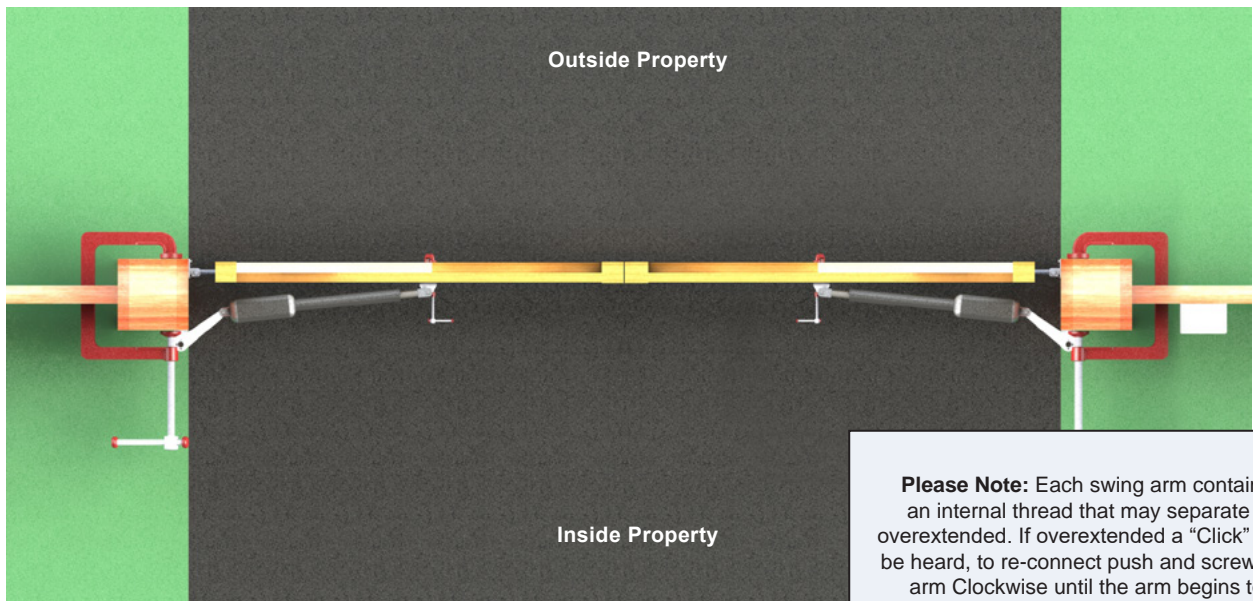

Fig 28

Do not proceed any further until you can achieve your full range of motion with everything positioned using clamps!

Push to Open Limit Switch Settings

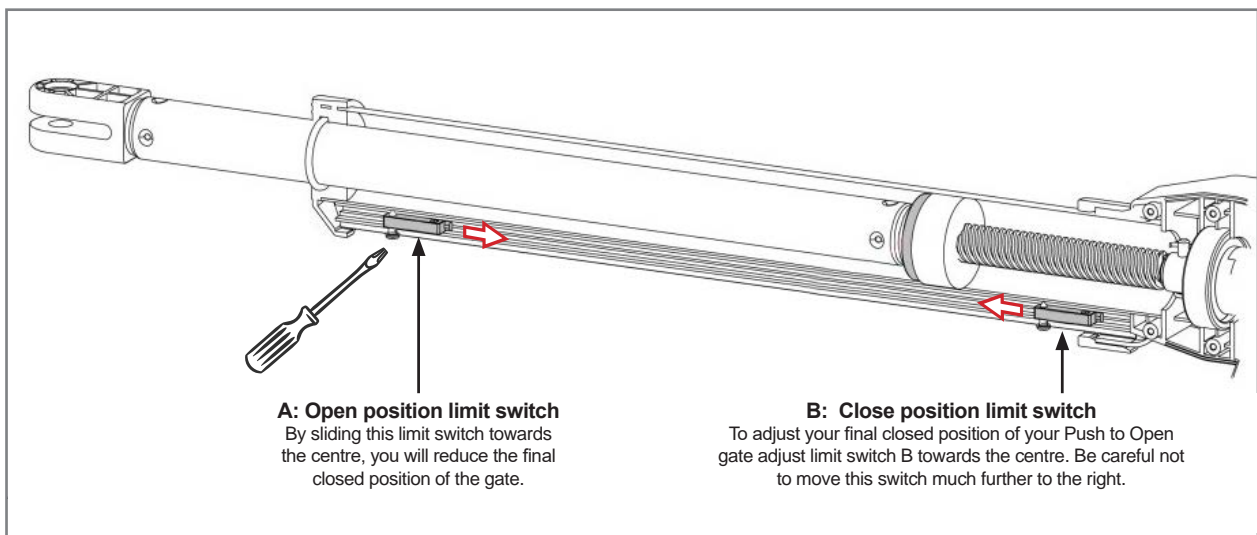

Fig 29

Troubleshooting:

Problem	Possible Reason	Solution
Digital display does not tun on	<ol style="list-style-type: none"> 1. Power had been disconnected 2. PCB fuse has blown 3. PCB is damaged 	<ol style="list-style-type: none"> 1. Check that the power cord is plugged in, and inspect the cord for damage 2. Check fuse on the PCB, replace if required 3. Contact Richmond Wheel & Castor Co for replacement PCB
The gate stops during opening/closing	<ol style="list-style-type: none"> 1. Stall force is set too low 2. Gate hinges are damaged 	<ol style="list-style-type: none"> 1. Increase the stall force (Settings P5 and P6, see Page 21 for info) to the minimum value that the gate opens 2. Re-grease hinges and check for any misalignment. Put the motor arm into manual mode and check that the gate opens freely by hand.
The gate stops immediately after it starts moving	<ol style="list-style-type: none"> 1. An obstruction is detected 2. Stall force is set too low 3. Max running time is set too low 	<ol style="list-style-type: none"> 1. Check for obstructions and remove 2. Test with increased stall force (Settings P5 and P6, see Page 21 for info). Set the stall force to the minimum value that the gate will function at. 3. Increase the maximum running time by adjusting settings P7 and P8 (refer to page 21)
Remote control doesn't work	<ol style="list-style-type: none"> 1. Remote control battery is flat 2. The remote is not paired correctly 	<ol style="list-style-type: none"> 1. Check that the LED in the control box lights up when the button is pressed. If not, change the remote control battery (A27 battery required) 2. Repeat the remote pairing procedure
Gate can open but doesn't close	<ol style="list-style-type: none"> 1. Photocells are obstructed 2. Photocells are not mounted correctly 	<ol style="list-style-type: none"> 1. Check and remove any obstructions 2. Make sure photocell beams are correctly positioned and at least 2mtrs apart.
Gate does not automatically closed	<ol style="list-style-type: none"> 1. Auto close settings are incorrect 2. Gate is incorrectly set to push-to-open or pull-to-open 	<ol style="list-style-type: none"> 1. Check that setting P9 is set correctly (refer to page 21) 2. Check that the motor cables are wired correctly for push-to-open or pull-to open
Gate arm won't retract	<ol style="list-style-type: none"> 1. The arm is overextended. (Each swing arm contains an internal thread that may separate if over-extended) 2. The gate is set up as push to open 	<ol style="list-style-type: none"> 1. Reset the internal thread on the gate arm. Refer to page 20 for instructions on how to do this 2. If the gate is set up as push to open, refer to page 20, and check that the gate wiring matches fig 21
Gate opens immediately after it closes	<ol style="list-style-type: none"> 1. Arm travel extension is being exceeded 	<ol style="list-style-type: none"> 1. Adjust your travel limit switch to be the correct setting or adjust the stall force

Technical Support:

For support or assistance with installing your gate motor, visit richmondau.com/gate-motor-support/

Or ring your local Richmond Wheel & Castor Branch

AU: 1300 474 246 **NZ:** 0800 61 71 81 **International:** +613 9551 2233

Richmond Wheel & Castor Co declines all responsibility for any consequences resulting from improper use of the product, or use which is different from that expected and specified in the present documentation.

Richmond Wheel & Castor Co declines all responsibility for any consequences resulting from failure to observe Good Technical Practice when constructing closing structures (door, gates etc.), as well as from any deformation which might occur during use.