







JOCKEY WHEELS

NEW

UP TO 400KG

Richmond Jockey Wheels are suitable for use on Caravans, Campers, Boat Trailers and a whole range of trailers used for transporting goods for leisure or business.

SPECIFICATIONS

 Diameter (mm)	 Width (mm)	 Wheel Type	 Load Capacity	 Raised Height (mm)	 Lowered Height (mm)	 Part Number
150	45	Black Rubber	350kg static	850	540	S6026
150	45	Black Rubber	350kg static	850	540	S6066
200	55	Rubber Tyred	400kg static	890	600	S8026
250	85	Rubber Tyred	400kg static	910	650	S1073

IMPORTANT NOTE:

When moving equipment best performance is achieved with jockey wheel being at a lowest position. Moving equipment with jockey wheel in a high position is not safe or advised. All load capacities are based on smooth concrete or asphalt surfaces.

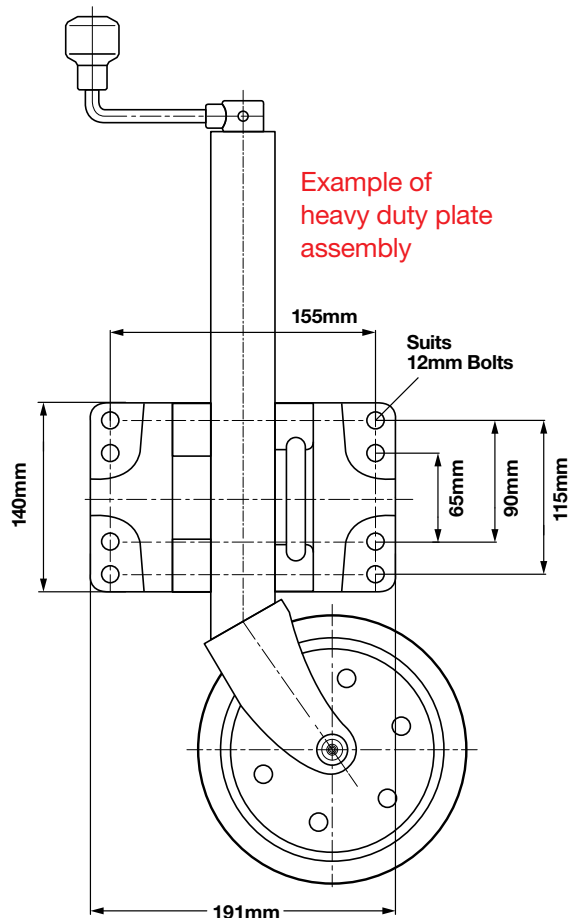

S8026, S1073, and S6066 feature a new heavy duty plate assembly designed to swing up and out of the way.